

HP 8753C Network Analyzer Documentation Map

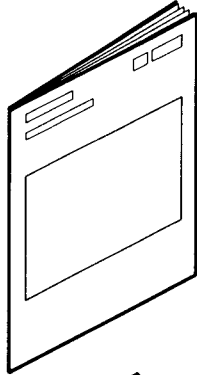

The **User's Guide** walks you through system setup and initial power-on, shows how to make basic measurements, explains commonly-used features, and tells you how to get the most performance from your analyzer.

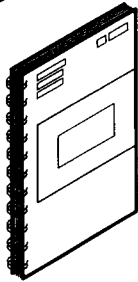

The **Quick Reference** provides a summary of all available user features. It is organized alphabetically by front panel key.

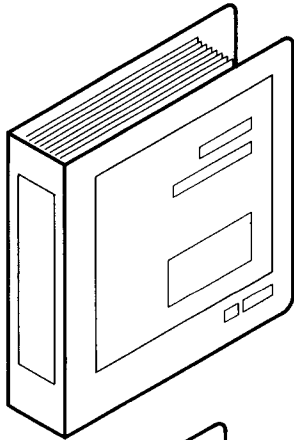

The **Operating Manual** provides general information, specifications, HP-IB programming information, and in-depth reference information.

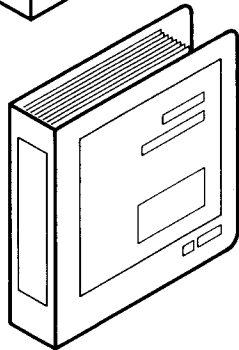

The **Service Manual** explains how to verify conformance to published specifications, adjust, troubleshoot, and repair the instrument.

Chapter 1	Installation	4
Chapter 2	Getting Acquainted with the HP 8753C Front Panel Description The Four Step Measurement Sequence A Simple Measurement Example	9
Chapter 3	Transmission Measurement Examples	12
Chapter 4	Reflection Measurement Examples	21
Chapter 5	Instrument Feature Tutorials Disk Drive Harmonic Measurements (option 002) Limit Lines Measurement Calibration Printing and Plotting Six GHz Operation (option 006) Test Sequencing Test Sets and S-Parameters Time Domain (option 010)	28
Chapter 6	How to Get the Most Out of the HP 8753C Increasing Measurement Accuracy Decreasing Sweep Time Increasing Dynamic Range	49

Installation

Introduction

Use this guide with the *Quick Reference* to install and learn how to operate your network analyzer alone or as part of a system. These are the main topics:

- Installation
- Operating the Analyzer
- Transmission Measurements
- Reflection Measurements
- Time Domain Measurements
- Using Limit Testing for Device Evaluation
- Selecting Test Frequencies with Frequency List Mode
- How To Get the Most Out of the Analyzer
- Index

**CAUTION**

Damage to the analyzer can result from electrostatic discharge (ESD). Use static-safe work stations and procedures.

Initial Considerations

Components of a network analyzer system may be shipped separately. Keep the shipping containers in one place and verify the completeness of the system before unpacking. If any container or instrument is damaged or incomplete, save the packing materials and notify both the carrier and Hewlett-Packard.

If you wish to have the analyzer installed, contact the HP customer engineer to arrange for this on a time and materials basis. Other service options are described in the "General Information" section of the *Operating Manual*.

Site Requirements

The analyzer will operate within a wide range of temperatures, altitudes, and levels of humidity. Table 2 in the "General Information" section of the *Operating Manual* has operating and storage specifics. Note that accuracy enhanced performance and some instrument specifications require an environmental temperature of $25^{\circ}\text{C} \pm 5^{\circ}\text{C}$.

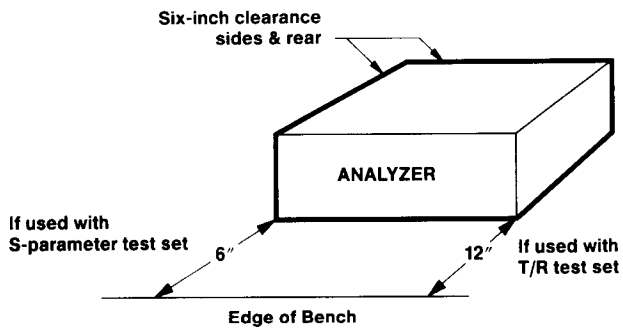
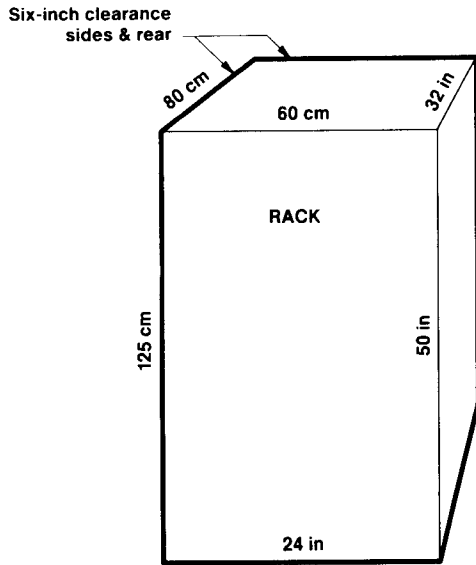

Analyzer and HP 85043B Rack Space Requirements

Setting up the Instruments

Make sure the serial number (shown below) on the analyzer's rear panel matches that of the shipping document.

For bench systems, use an anti-static mat (such as HP 92175T) and wrist straps. Place the mat on the bench and the analyzer on the mat.

For HP 85043B rack systems, follow the instructions provided in that manual.

For non-HP 85043B rack systems, note that these racks may promote shock hazards, overheating, dust contamination, and inferior system performance. Consult your HP customer engineer about installation, warranty, and support details. Rack mount kits are available for mounting the analyzer with front handles in 19 inch racks. The kit is option 913, available as HP part number 5062-4074.

Place other system instruments (computer, printer, plotter, disk drive) where convenient, within the following HP-IB cable length limits.

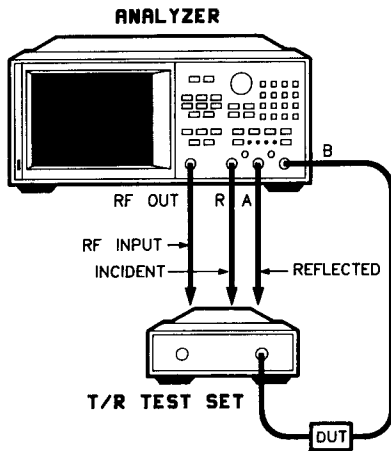
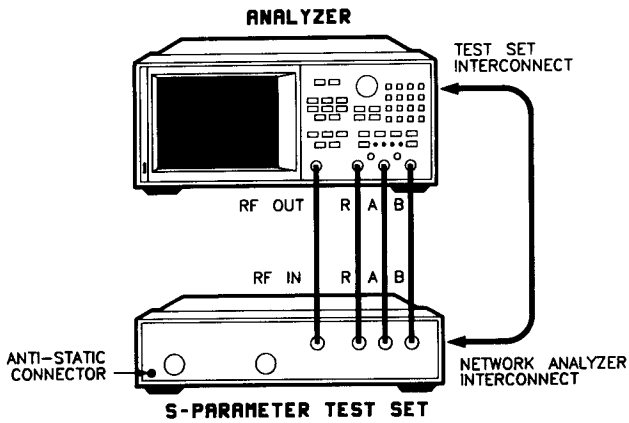

Analyzer and Test Set Connections

HP-IB and Power Considerations

HP-IB enables system instruments to communicate. Connect the system instruments with HP-IB cables in any order. The other system instruments have HP-IB connectors (shown below) similar to that of the analyzer. Tighten the knurled screws on each of the HP-IB cables.

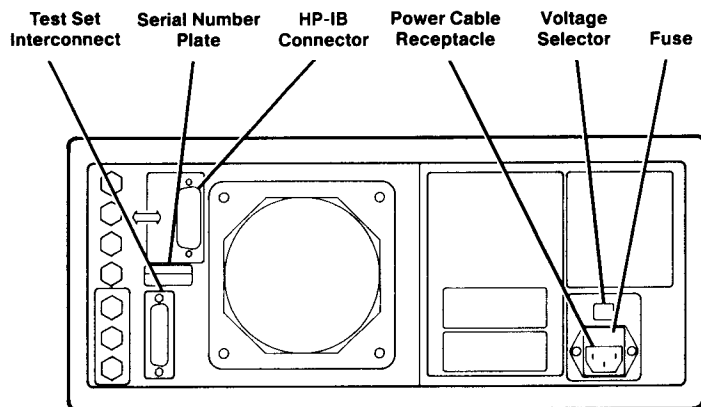

Rear Panel of Analyzer

Instruments in System	Maximum HP-IB Cable Length	Cable Length (approximate)	Part Number
Two	4 m	4 m (13 feet)	HP 10833C
Three or more	2 m	2 m (6 feet)	HP 10833B
		1 m (3 feet)	HP 10833A
		0.5 m (1.5 feet)	HP 10833D
Fifteen (max)	20 m (Total)		

AC Line Voltage Setting

Confirm that the analyzer voltage selector (shown above) is set to match the AC line voltage before plugging in the analyzer. Fuse size is specified on the instrument rear panel. The working fuse and a spare are located in the power cable receptacle.

Nominal Setting	AC Line Power
115V	90V to 132V (at 48 to 66 Hz)
230V	198V to 264V (at 48 to 66 Hz)

WARNING

Avoid personal injury and instrument damage: use power outlets with a protective earth (third wire) contact only.

If the AC line voltage is not within either range, use an autotransformer.

CAUTION

Avoid instrument damage: make certain the autotransformer provides third wire continuity to earth ground.

AC Line Power Cables and Power-On

Use the three-wire power cable supplied with each instrument. This cable grounds the instrument (as required) when connected to an appropriate outlet. To order power cables with different plugs, contact your local HP customer engineer (or see the "Replaceable Parts" section of the *Service Manual*).

Turn on the line switch of each instrument (analyzer last). Check that each instrument is on and has passed its self test, if any. If an instrument malfunctions, refer to its manual (for the analyzer, it is the *Service Manual*.)

HP-IB Addresses

To communicate via HP-IB, (1) each device must have a unique address and (2) the analyzer must recognize each address. To check each device's HP-IB address, refer to its manual (most addresses are set with switches). To check the analyzer's address, press the [LOCAL] key and the [SET ADDRESSES] [ADDRESS 8753] softkeys. The analyzer's address will appear.

The HP-IB addresses shown are the factory-set addresses of the devices. They are also the default addresses recognized by the analyzer.

Device	HP-IB Decimal Address
8753	16
Printer	5
Plotter	1
Disk (drive)	0
Controller (computer)	21
P Mtr (power meter)	13

To change an address (recognized by the analyzer) to match a device address, press the device softkey and then enter the address and [x1].

To learn how to use the network analyzer, continue with the next chapter. The analyzer has already passed its self-test and should be ready to make measurements.

If you need to check the instrument more rigorously (incoming inspection, for instance), refer to the *Service Manual*.

Getting Acquainted with the HP 8753C

Front Panel Description

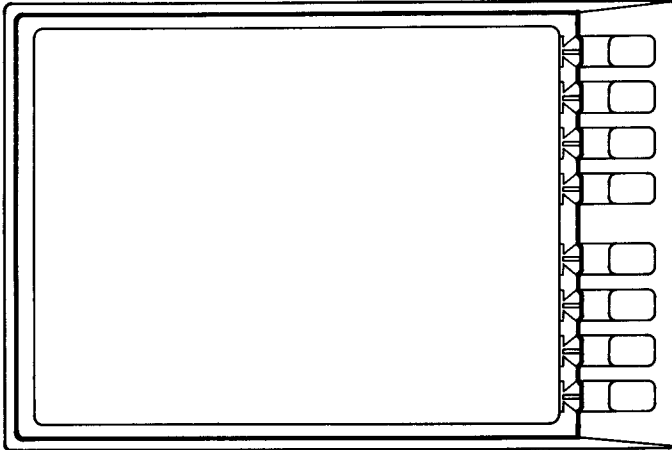

One of the more noticeable characteristics of the HP 8753C is the simplicity of its front panel. Rather than individual keys for each of the many instrument functions, the analyzer uses CRT-displayed "menus" for operator input. These menus list the possible choices for a particular function, with each choice corresponding to one of the eight "softkeys" located to the right of the CRT.

The "hard keys" on the front panel provide access to the various menus, and are grouped by function.

Active Channel

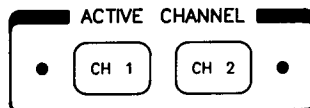

The analyzer has dual trace capability with many of the measurement and display functions independently selectable for each trace. To modify the parameters of a particular trace, first select channel one or two, and then make the desired measurement choices. Note that the LED next to the channel selected is lit.

Response

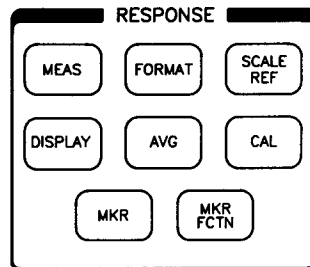

The network analyzer's receiver section is controlled with these keys. The top three keys allow the user to choose measurement configuration (A, B, B/R, etc.), presentation format (amplitude and phase versus frequency, Smithchart, polar coordinates, etc.), and scale and reference values for a full screen display.

The lower five keys in this section enhance the usability of the measured data. The displayed traces may be overlaid, manipulated with math function keys, averaged, normalized, or read out at specific points along the trace with up to four independent markers per channel.

Stimulus

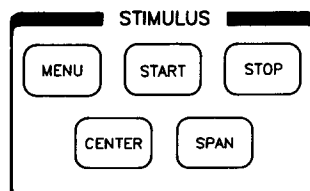

These keys allow the user to define an appropriate source output signal for the device under test. Source frequency may be swept over any portion of the range 300 kHz to 3 GHz, at power levels between +20 and -5 dBm. The Stimulus keys can also control the start and stop times in the (optional) time domain mode. The choices for sweep time and resolution, linear versus logarithmic sweep, power sweep, etc. are also selected here.

Data Entry

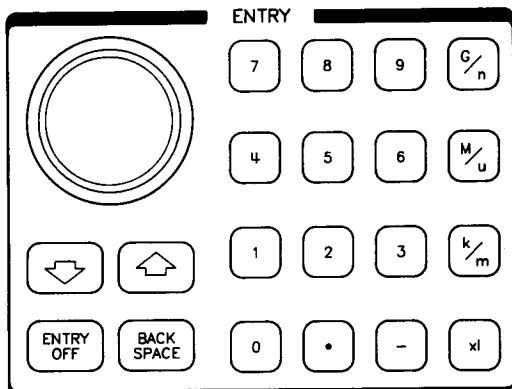

In some cases it is necessary to supply numeric values for a chosen parameter, such as frequency or amplitude. The ten-digit keypad is used to supply these values. The keys to the right of the digits terminate the data entry with the appropriate units. Use [**G/n**] (Giga/nano), [**M μ**] (Mega/micro), [**k/m**] (kilo/milli) and [**x1**] (basic units: dB, dBm, degree, second, Hz) as applicable. In addition to entering data with the keypad, the knob can be used to make continuous adjustments, while the [**▼**] and [**▲**] buttons allow values to be changed in steps.

Instrument State

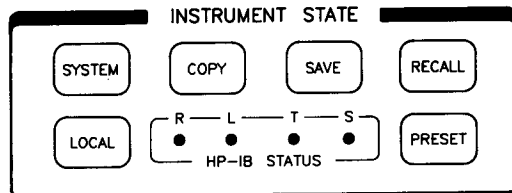

Several utility functions are implemented with these keys, including instrument preset, front panel save/recall memory, HP-GL plotter control, time domain transform (optional) and built-in diagnostic tests.

Four Step Measurement Sequence

This simple sequence is used throughout the guide to illustrate the use of the HP 8753C.

- 1. Choose Measurement Settings** Press the [**PRESET**] key to perform a self test and return the instrument to a known state. (Many preset conditions are visible on the CRT; all are defined in the "Reference" section of the *Operating Manual*.) Then choose the instrument settings appropriate for the intended measurement (this may require temporary connection of the DUT).
- 2. Perform Measurement Calibration** Establish a magnitude and phase reference for the test setup and then remove measurement errors to the desired degree.
- 3. Measure the Device Under Test** Connect the device under test (DUT) and measure it.
- 4. Output the Result** Output the data to a printer, plotter or memory.

A Simple Measurement Example

The examples in this guide are based on a HP 8753C/S-parameter system connected according to the "Installation" instructions. Regardless of the type of measurement (transmission or reflection) you will normally make on your own DUT, perform the examples in this guide in order. They build on each other and introduce many important instrument functions and concepts.

One concept is the difference between "hardkeys" (the labeled, predefined front panel keys) and "softkeys" (the 8 unlabeled keys next to the CRT). In this guide the two types of keys are differentiated this way:

[HARDKEY] [SOFTKEY]

To perform this measurement example, connect a cable (or pair of cables) between ports 1 and 2. This "DUT" is called a "thru".

1. Choose Measurement Settings

Press [PRESET] and choose these measurement settings:

Measurement	S12 (or A/R) on CH 2
Format	LOG MAG
Stimulus	START 1 MHz STOP 1 GHz

Then adjust the scale/division to 0.5 db. (Note the frequency response of the cable.)

2. Perform Measurement Calibration

Press [CAL] [CALIBRATE MENU] [RESPONSE] to begin a frequency response measurement calibration. The thru is already connected. Press [THRU] [DONE: RESPONSE] to complete the calibration.

3. Measure the Device Under Test

In this simple example, the device is the thru. It is being measured. To see how the measurement accuracy increased with the measurement calibration, toggle [CORRECTION] on and off.

4. Output the Result

Press [LOCAL] [SYSTEM CONTROLLER] [COPY] [PRINT] to print a copy of the result (details in "Printing and Plotting" tutorial); or just observe the result.

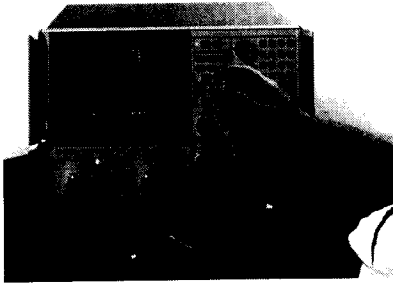

Transmission Measurement Examples

The next two chapters demonstrate the many kinds of network measurements that can be made with the HP 8753C. For each example a complete measurement setup is given, following the same "Four Step Measurement Sequence" described in Chapter 2.

The examples used represent typical network measurements. The DUT used in the examples is a bandpass SAW filter with a 134 MHz center frequency. Modify the instrument setups shown to suit your particular needs. For further information on any of the measurements shown, refer to the HP 8753C Operating Manual for the most complete description of allowable operating modes, parameters, etc.

Basic Setup

Most of the examples described in this chapter use the HP 85046A/B or HP 85047A S-parameter test set to connect to the device under test. This approach simplifies the measurement setup, and provides fully specified results over the analyzer's frequency range. Fully specified measurements can also be made using the HP 85044A/B transmission/reflection test set. Or you can create your own test setup with discrete power splitters, couplers, attenuators, etc. If you use your own setup, note that the analyzer requires a signal level at the R input in the range of 0 to -35 dBm to phase lock the internal source.

Measuring Insertion Loss and Gain

Insertion loss and gain are ratios of the output to input signals. When set up as shown below, the results can be read directly in decibels.

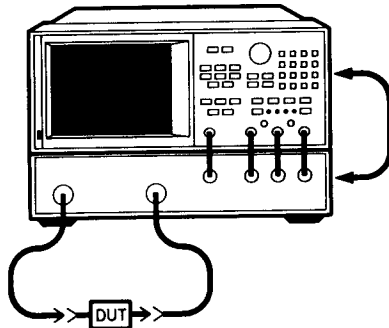

Connect the S-parameter test set to the network analyzer as explained in chapter 1, "Installation"

1. Choose Measurement Settings

Press [PRESET] and choose these measurement settings:

Measurement	S21 (or B/R) on CH 1
Format	LOG MAG
Stimulus	CENTER 134 MHz
	SPAN 30 MHz

2. Perform Measurement Calibration

Press [CAL][CALIBRATE MENU][RESPONSE] to begin a frequency response calibration. Connect a "thru" between the measurement cables and then press [THRU]. Press [DONE:RESPONSE] to complete the calibration.

3. Measure the Device Under Test

Replace the thru with the DUT. Press [SCALE REF] and [AUTOSCALE] if the trace needs to be repositioned. Press [MKR][134.75][M/ μ] to set the marker as shown. Note that the CRT (and figure) show the complete response of the bandpass filter under test.

4. Output the Result

Press [LOCAL][SYSTEM CONTROLLER][COPY][PLOT] to plot a copy of the result (details in "Printing and Plotting" tutorial). Or just observe the result.

Measuring Other Aspects of Insertion Loss with Marker Functions

From this display you can derive several important filter parameters. The power of the marker functions greatly simplifies this task.

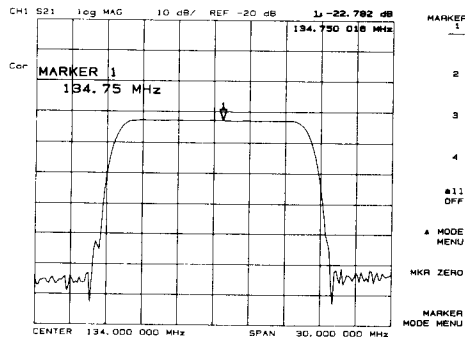

Insertion Loss

Insertion loss can be read to 0.001 dB resolution by moving the marker to any frequency of interest. The marker amplitude and frequency are read in the upper right hand corner of the display.

3 dB Bandwidth

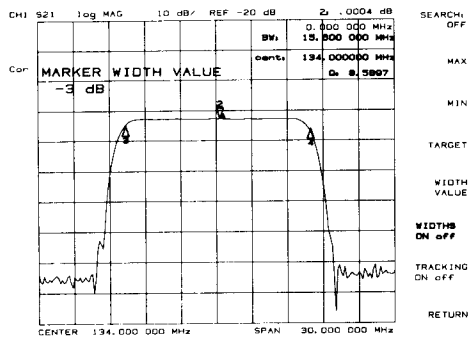

The HP 8753C calculates the bandwidth of the DUT between two equal power levels. In this example, we calculate the -3 dB bandwidth relative to the filter center frequency.

1. Press **[MKR]** and use the rotary knob to move the marker to the center of the filter passband. Press **[MKRZERO]** to zero the delta magnitude and frequency. The softkey label changes to **[MKR ZERO Δ REF = Δ]** to remind you that the delta reference point is the small Δ symbol.

2. Press **[MKR FCTN]** **[MKR SEARCH]** to enter the marker search mode. Select **[WIDTHS ON]**. The HP 8753C calculates the -3 dB bandwidth, the center frequency and the Q (Quality Factor) of the DUT and lists the results in the upper right hand corner of the display. Markers 3 and 4 on the trace show the location of the -3 dB points. To have the HP 8753C calculate the band width between other power levels, select **[WIDTH VALUE]** and enter the number (for example: **[$-$][6][x1]** for -6 dB). Press **[WIDTHS OFF]** and **[RETURN]** when you are finished with this measurement.

Out-of-Band Rejection

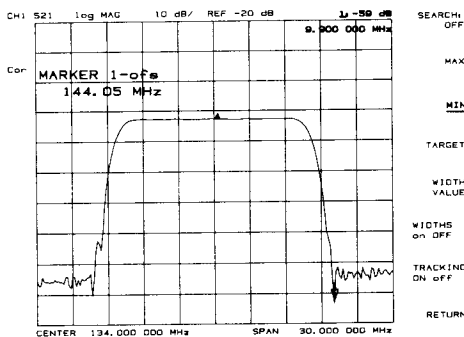

The wide dynamic range of the HP 8753C allows it to measure stopband rejection up to 110 dB below the pass band response. As discussed in chapter 6, "Increase Dynamic Range", maximum dynamic range requires proper selection of input power level, IF bandwidth and averaging.

Press **[MKR SEARCH]** **[SEARCH: MIN]**. The marker automatically seeks the minimum point on the trace. The frequency and amplitude of this point, relative to the delta symbol in the center of the filter Passband, appear in the upper right hand corner of the display.

Note that the marker search mode can be used to search the trace for the maximum point or for any target value. The target value can be an absolute level (for example: -3 dBm) or a level relative to the small delta symbol (for example: -3 dB from the center of the passband).

Press **[SEARCH: OFF]** and **[RETURN]** when you are finished with this measurement.

Ripple or Flatness

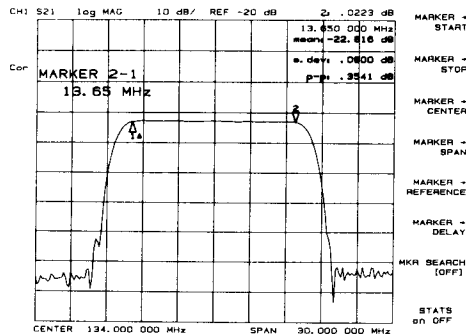

The power of marker statistics is illustrated in this measurement of passband ripple. Passband ripple (or flatness) is the variation in insertion loss over a specified portion of the passband.

1. Press **[MKR]** and use the rotary knob to move marker 1 to the left edge of the passband. Press **[Δ MODE MENU] [Δ REF = 1]** to move the delta reference point to marker 1's position along the trace.
2. Press **[MARKER 2]** and turn the rotary knob to move marker 2 to the right edge of the passband.
3. Press **[MKR FCTN] [STATS ON]**. The analyzer calculates the mean, standard deviation and peak-to-peak variation between the markers and lists the results in the upper right hand corner of the display. The passband ripple is automatically given as the peak-to-peak variation between the markers.

Select **[STATS OFF]** when you are finished with this measurement.

Measuring Phase Response

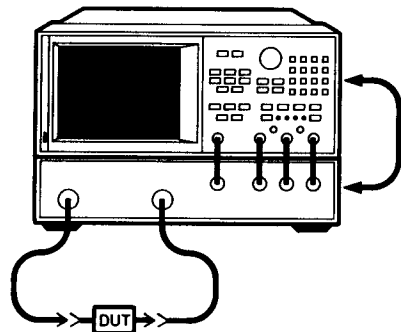

A two input ratio measurement can also provide information about the phase shift or insertion phase of a network. The HP 8753C can translate this information into a related parameter, group delay.

1. Choose Measurement Settings

Press **[PRESET]** and choose these measurement settings:

Measurement	S21 (or B/R) on CH 1
Format	PHASE
Stimulus	CENTER 134 MHz SPAN 30 MHz

2. Perform Measurement Calibration

Press **[CAL] [CALIBRATE MENU] [RESPONSE]** to begin a frequency response calibration. Connect a "thru" between the measurement cables and then press **[THRU]**. Press **[DONE:RESPONSE]** to complete the calibration.

3. Measure the Device Under Test

Replace the thru with the DUT. Press **[SCALE REF]** and **[AUTOSCALE]** if the trace needs to be repositioned.

4. Output the Result

Press [LOCAL][SYSTEM CONTROLLER][SAVE][STORE TO DISK][STORE FILE *nm*] to store the result (data trace, measurement settings, and calibration) on an external disk. (See the "Disk Drive" tutorial for details.) Or just observe the trace.

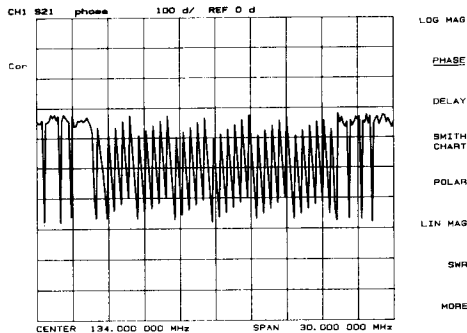

Just as in measuring insertion loss or gain, the various marker functions (marker search, min/max, offset, etc.) can be used to examine the details of the phase response.

The figure shows the phase response of the bandpass filter. Notice the linear phase shift through the passband, and the rapid fluctuations outside this region. The random phase of the broadband noise floor causes the spurious out-of-band response.

The analyzer measures and displays phase over the range -180 to $+180$ degrees. As phase increases beyond these values, a sharp 360 degree transition occurs in the display as the trace "wraps" between $+180$ and -180 degrees. This causes the characteristic "sawtooth" display usually seen on devices with linearly increasing (or decreasing) phase responses.

Using the Dual Trace Display

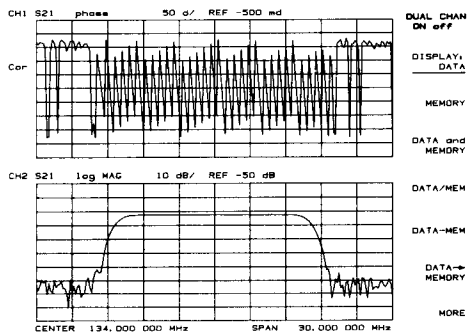

In some cases it is useful to be able to view more than one measured parameter at a time. Simultaneous gain and phase measurements for example, are useful in evaluating stability in negative feedback amplifiers. Such measurements are easily made using the dual channel display.

To see both channels simultaneously, press [DISPLAY][DUAL CHAN ON]. Two displays appear on the CRT, with channel 1 on the upper and channel 2 on the lower display.

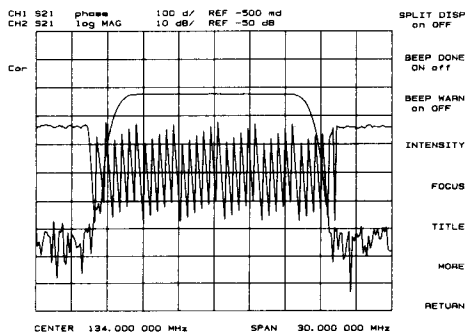

Sometimes it is more convenient to view both channels on a single graticule. In the [DISPLAY] menu, press [MORE][SPLIT DISP OFF].

Press [SPLIT DISP ON], [RETURN] and [DUAL CHAN OFF] when you are finished with this measurement.

Measuring Electrical Length

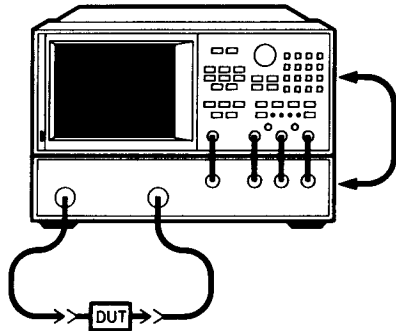

The HP 8753C electronically implements a function similar to the mechanical "line stretchers" of earlier analyzers. This feature simulates a variable length loss less transmission line, which can be added to or removed from a receiver's input to compensate for interconnecting cables, etc. In this example, the electronic line stretcher is used to measure the electrical length of a test device.

1. Choose Measurement Settings

Press [PRESET] and choose these measurement settings:

Measurement	S21 (or B/R) on CH 1
Format	PHASE
Stimulus	CENTER 134 MHz SPAN 2 MHz

2. Perform Measurement Calibration

Perform a frequency response measurement calibration as in the previous examples.

3. Measure the Device Under Test

Replace the thru with the DUT and reposition the trace as before.

4. Output the Result

Print, plot, save to disk or just observe as before.

Electrical Length Adjustment

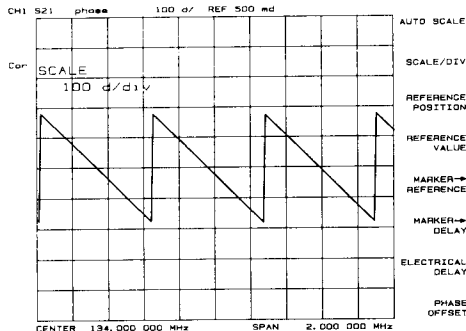

The above setup results in the phase response measurement shown. Note that the SAW filter under test has considerable phase shift within only a 2 MHz span. Other filters may require a larger frequency span to see the effects of phase shift.

The linearly increasing phase is due to the DUT's electrical length, which will be measured by electronically adding length to the R input to compensate for it.

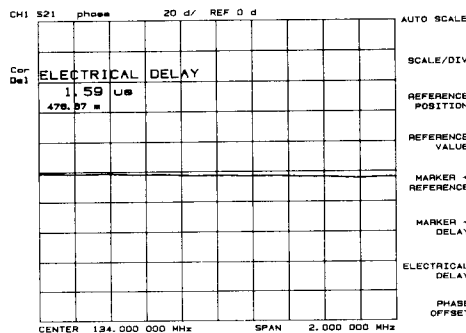

1. Activate the line stretch function by pressing **[SCALE REF]** **[ELECTRICAL DELAY]**.

2A. Next, use the rotary knob to adjust the amount of length added to input R until the display is flat as shown.

or

2B. Press **[MKR]** and use the rotary knob to position marker 1 near the center of the screen. Press **[SCALE REF]** and select **[MARKER → DELAY]**. The analyzer adds electrical length equal to the group delay (discussed next) at the marker frequency for a flat phase response just as in 2A above. To display the electrical length, press **[ELECTRICAL DELAY]**.

In this example we added a large amount of electrical delay due to the long electrical length of the SAW filter under test.

Measuring Phase Distortion

For many networks, the amount of insertion phase is not nearly as important as the linearity of the phase shift over a range of frequencies. The analyzer can measure this linearity and express it in two different ways: directly, as deviation from linear phase, or as group delay, a derived value.

Deviation from Linear Phase

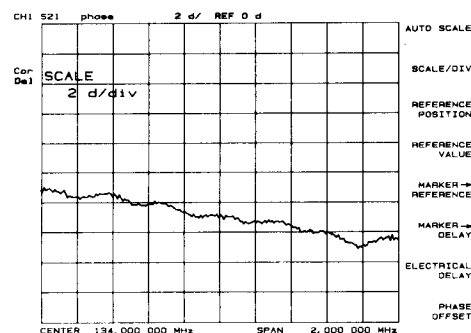

This can be measured using the previous setup for measuring electrical length. By adding electrical length to "flatten out" the phase response we have removed the linear phase shift through the DUT. What remains is the deviation from linear phase shift through the device. Simply increase the scale resolution to directly measure the deviation from linear phase.

Group Delay

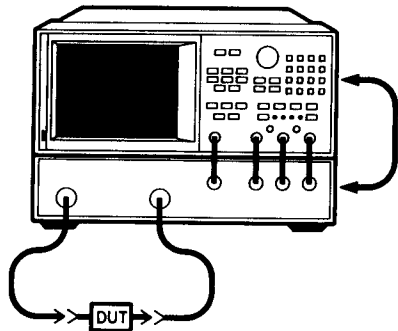

The phase linearity of many devices is specified in terms of group or envelope delay. This is especially true of telecommunications components and systems.

Group delay is the transmission time through the DUT as a function of frequency. Mathematically, it is the derivative of the phase response which can be approximated by the ratio

$$\frac{\Delta\phi/360}{\Delta F}$$

where $\Delta\phi$ is the difference in phase at two frequencies separated by ΔF . The quantity ΔF is commonly called the "aperture" of the measurement. The analyzer calculates group delay from its phase response measurements.

Continue with the same instrument settings and measurements.

The default aperture is the frequency span divided by the number of points across the display (i.e. 201 points or 0.5% of the total span in this example). Other aperture values can be selected by turning on **[SMOOTHING]** and varying the **[SMOOTHING APERTURE]** in the **[AVG]** menu.

Notice the effect of aperture on a group delay measurement. As the aperture is increased from 0.5 to 2 and higher, the "smoothness" of the trace improves markedly, at the expense of measurement detail.

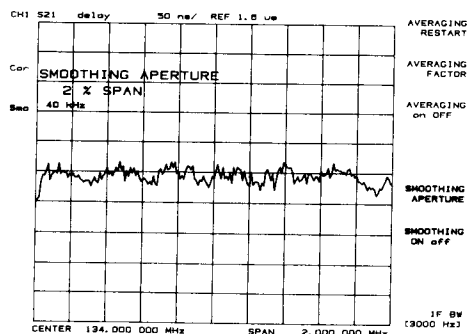
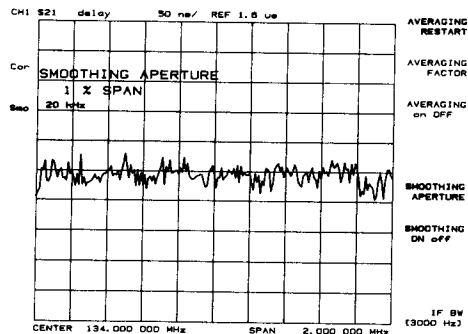
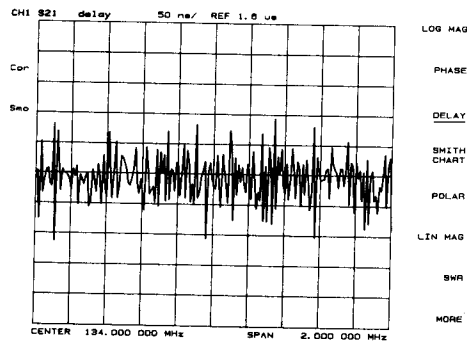

Measuring Gain Compression

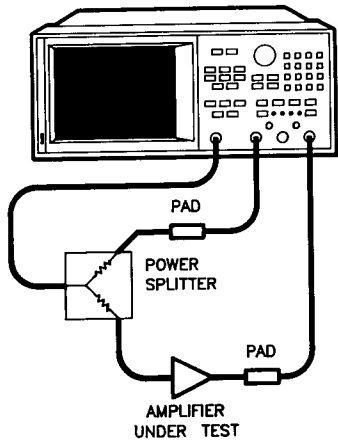

Measurements to this point have all been made with a constant input amplitude and swept test frequency range. At times, however, it may be desirable to characterize a device at a single frequency as a function of input amplitude. By using the power sweep mode, measurements such as gain compression or AGC (automatic gain control) slope can be made.

Use the setup shown; the S-parameter test set is not used because it has a relatively high insertion loss. That loss limits the input signal available to drive the amplifier into compression.

1. Choose Measurement Settings

Press **[PRESET]** and choose these measurement settings:

Measurement	S21 (or B/R) on CH 2
Format	LOG MAG
Stimulus	Press MENU
	CW FREQ 100 MHz
	SWEEP TYPE MENU
	POWER SWEEP
	START -5 dBm
	STOP +5 dBm

2. Perform Measurement Calibration

Substitute a thru in place of the amplifier and perform a frequency response measurement calibration as before.

3. Measure the Device Under Test

Replace the thru with the DUT and reposition the trace as before. Press **[MKR]/[MKR ZERO]** and rotate the knob to measure the gain compression of the amplifier.

4. Output the Result

Output the result as before.

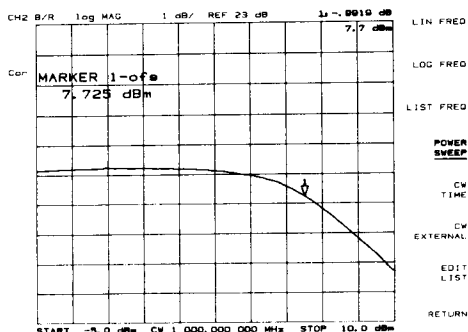

The figure shows the gain rolling off as the input power increases to a level where the amplifier under test exhibits gain compression. While the +20 dBm maximum output from the network analyzer will be sufficient for many compression tests, it is also possible to add an external amplifier in series with the source to provide additional drive. Remember to limit the input power to the analyzer to 0 dBm maximum, adding external attenuators if necessary.

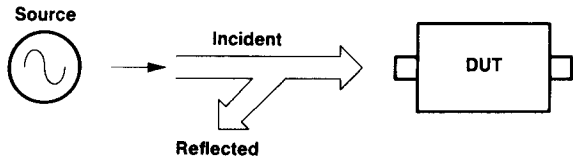

Reflection Measurement Examples

The transmission measurements discussed in chapter 3 are only part of the network measurements picture. Measuring the return loss or reflection coefficient completes the device characterization, and provides the basis for calculating parameters such as impedance and SWR. This chapter demonstrates how to set up, make and interpret reflection measurements with the HP 8753C.

Basic Setup

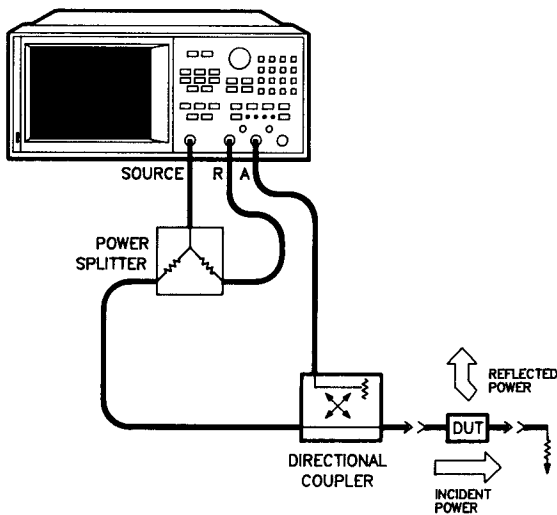

Reflection measurements require a directional device, such as a directional coupler, in the measurement setup. This signal separator provides a sample of the power traveling in one direction only. For reflection measurements it is connected as shown in the figure, allowing the power reflected from the DUT to be separated and measured independently of the incident power. The ratio of these two signals is the reflection coefficient of the DUT or, when expressed in decibels, the return loss.

Many types of directional couplers and bridges are available to perform this function. They are differentiated by frequency range, directivity and connector type. The most convenient approach is to use a HP 85046A/B or HP 85047A S-parameter test set or an HP 85044A/B transmission/reflection test set. These test sets provide the necessary hardware and interconnect functions for reflection measurements from 300 kHz to 3 GHz (or 6 GHz with the HP 85047A). The examples in this chapter use an S-parameter test set.

Multi-Port Test Devices

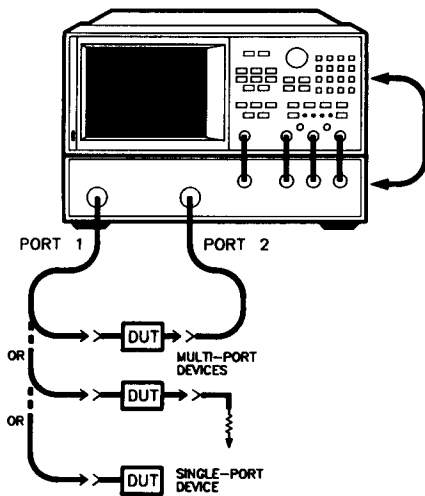

Reflection measurements are made with only one port of a test device. But when the device has more than one port, care must be taken to insure that the unused port(s) are properly terminated in their characteristic impedance (e.g. 50 or 75 ohms). If this is not done, reflections off the unused ports will cause measurement errors.

Connect high quality terminations (loads) to all unused ports. With an S-parameter test set, measurement port 2 supplies this termination during measurements of S_{11} and S_{21} , while port 1 supplies the load for measurements of S_{12} and S_{22} . All switching is automatic, controlled by the analyzer. When using a transmission/reflection test set, terminate the unused port at the B input of the analyzer or with a high quality load.

Measurement Accuracy

In reflection measurements, the accuracy of the final result is highly dependent on the signal separation device, adapters, and the DUT terminations. Systematic errors such as the frequency response of the test setup, leakage signals, and mismatches degrade overall measurement accuracy. The analyzer's built-in measurement calibration routines can remove these measurement errors as explained in the "Measurement Calibration" tutorial. The most accurate measurement calibration (full 2-port) is used in the first setup in this chapter. Subsequent setups use the simpler 1-port calibration.

Measuring Return Loss, Reflection Coefficient, and Standing Wave Ratio (SWR)

The signal reflected from the device under test is measured as a ratio with the incident signal. It can be expressed as reflection coefficient, a return loss, or SWR. These measurements are mathematically defined as:

$$\text{return loss (dB)} = -20 \log(\rho)$$

$$\begin{aligned} \text{reflection coefficient} &= \frac{\text{reflected power}}{\text{incident power}} = \rho \text{ (magnitude only)} \\ &= \Gamma = S_{11} \text{ or } S_{22} \\ &\quad \text{(magnitude and phase)} \end{aligned}$$

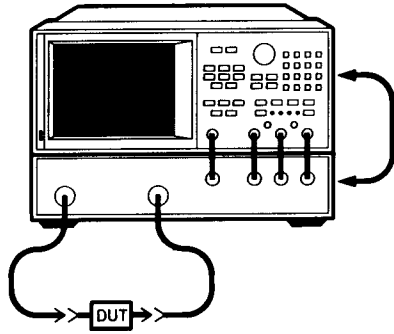

Connect the S-parameter test set to the analyzer as shown. The DUT will be the SAW filter used previously.

1. Choose Measurement Settings

Press **[PRESET]** and choose these measurement settings:

Measurement	S11 (or A/R) on CH 1
Format	LOG MAG
Stimulus	START 119 MHz STOP 149 MHz

(If you press **[CENTER]** and **[SPAN]** now, you'll display the same frequencies previously entered; use whichever format is easier.)

2. Perform Measurement Calibration

For maximum accuracy do a full 2-port calibration. Press **[CAL]**, select **[CALIBRATE MENU]**, **[FULL 2-PORT]**, **[REFLECT'N]** and follow the prompts to connect and measure an open, short and load for port 1 (S_{11}) and port 2 (S_{22}). Connect the standards at ports 1 and 2 using any adapters or cables that will be used in the actual measurement. Select **[REFLECT'N DONE]** after measuring these six standards. Next select **[TRANSMISSION]**, connect a "thru" and select the four transmission measurements, one at a time. Select **[TRANS.DONE]** when done. Finally, select **[ISOLATION]**, **[OMIT ISOLATION]** and **[ISOLATION DONE]**. Isolation accuracy enhancement, as described in chapter 5, "Measurement Calibration", is not required for this measurement.

3. Measure the Device Under Test

Replace the thru with the DUT and reposition the trace as before. Press **[MKR]** to activate the marker. You will measure the DUT in three different formats next.

Return Loss

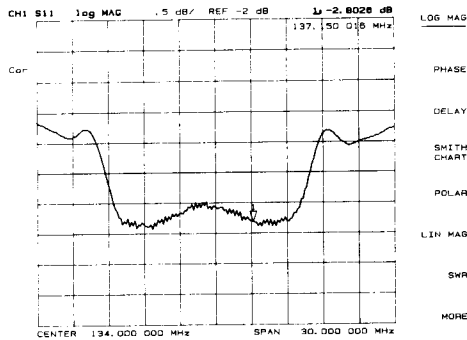

The results of a typical reflection measurement are shown. This device does not have very good match inside the filter passband, although it does illustrate that within the filter passband, the device matches the system impedance more closely than outside the passband. Therefore, the reflected signal in the filter passband is smaller than outside the passband. In terms of return loss, the value inside the passband is larger than outside the passband. A large value for return loss corresponds to a small reflected signal just as a large value for insertion loss corresponds to a small transmitted signal.

Reflection Coefficient

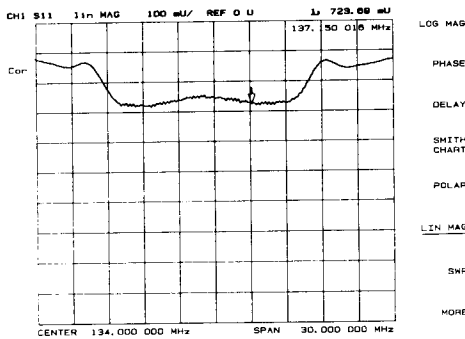

To display the same data in terms of reflection coefficient, press **[FORMAT]/[LIN MAG]**. This simply redisplay the existing measurement in a linear magnitude format that varies from $\Gamma = 1.00$ at the top of the display (100% reflection) to 0.00 at the bottom of the display (perfect match).

Standing Wave Ratio

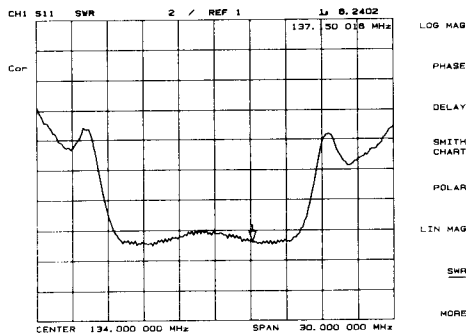

To display the reflection measurement data in terms of standing wave ratio (SWR), press **[FORMAT]/[SWR]**. The analyzer reformats the display in the unitless measure of SWR with $SWR = 1$ (perfect match) at the bottom of the display.

4. Output the Result

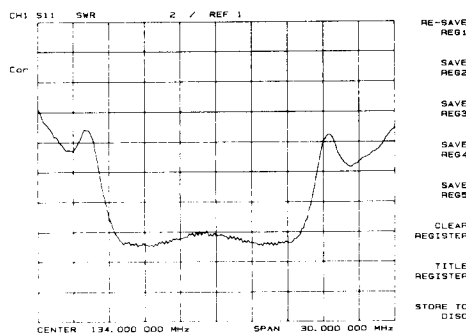

After completing the full 2-port calibration you may want to save the results for future measurements. The analyzer has five memory registers that you can use to store up to five instrument states. Because instrument states can be very complex, it is possible to fill the available memory with less than five states.

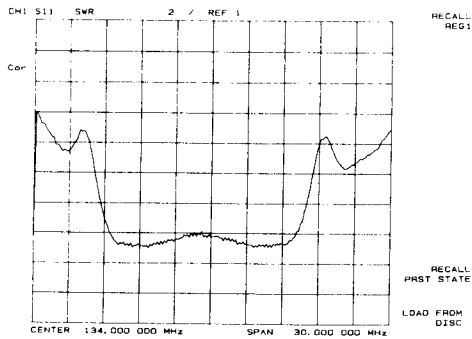

To save the instrument state in internal memory simply press **[SAVE]** and select one of the five registers (for example, select **[SAVE REG 1]** to save the instrument state in register 1). After you save the instrument state, the softkey label changes from **[SAVE REG n]** to **[RE-SAVE REG n]**. The analyzer saves all the selections you made to set up your desired measurement, such as start and stop frequency, measurement, format, calibration, scaling and limit lines. To recall the instrument state at some later time, press **[RECALL]** and select the desired register.

The complete instrument state, except calibration data and limit lines, remain saved for at least three days, if power is turned off. The analyzer saves the complete instrument state, including the calibration data and limit lines, indefinitely with power on.

For further save/recall memory, connect a compatible disk drive (for example, the HP 9122D/S), and save the instrument state on disk.

Measuring S-Parameters S_{11} and S_{22} in a Polar Format

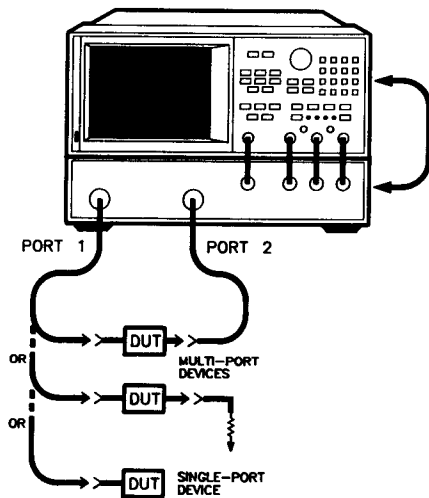

These parameters are really no different from the measurements made in the previous section. S_{11} is the complex reflection coefficient of the DUT input, while S_{22} is the complex reflection coefficient of the DUT output. In both cases, all unused ports must be properly terminated.

The S-parameter test sets automatically switch the measurement configuration to agree with the S-parameter selected from the **[MEAS]** menu. With the HP 85044A/B transmission/reflection test set, or with a test setup constructed from discrete couplers, pads and power splitters, it is necessary to reverse the connections to the DUT between measurements of S_{11} and S_{22} .

1. Choose Measurement Settings

Press **[PRESET]** and note the instrument setup. Since you are about to remeasure the same DUT, you can quickly make most of the required measurement settings by recalling the previously saved instrument state. Press **[RECALL]** **[RECALL REG n]**. Choose polar format.

2. Perform Measurement Calibration

Note the annotation "Cor" to the left of the graticule: the analyzer recalled and turned on the previous measurement calibration. You need not perform another calibration now although a 1 port calibration would suffice.

3. Measure the Device Under Test

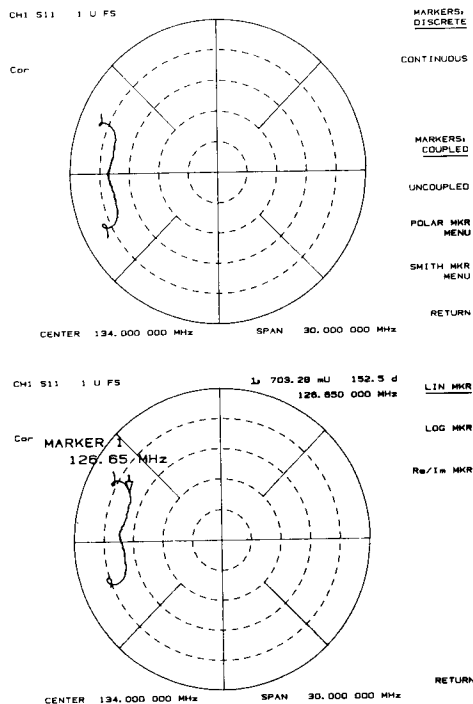

Rescale and position the trace if desired.

The results of a typical S_{11} measurement are shown, with each point on the polar trace corresponding to a particular value of both magnitude and phase. The center of the circle represents a coefficient Γ of 0, that is, a perfect match or no reflected signal. The outermost circumference of the scale represents $\Gamma = 1.00$, or 100 percent reflection. The phase angle is read directly from this display. The 3 o'clock position corresponds to zero phase angle, that is, the reflected signal is at the same phase as the incident signal. Phase differences of 90, 180 and 270 degrees correspond to the 12, 9, and 6 o'clock positions on the polar display, respectively.

The magnitude and phase of S or S_{11} are most easily and accurately read using the markers. Use the knob to position the marker at any desired point on the trace, then read the frequency, magnitude and phase in the upper right hand corner of the display. Or enter the frequency interest from the data entry keypad to read the magnitude and phase at that point. To read the marker data in either logarithmic or real/imaginary formats, press **[MKR]** and select **[MARKER MODE MENU]**, **[POLAR MKR MENU]**.

4. Output the Result

Output the result as you wish.

Measuring Impedance

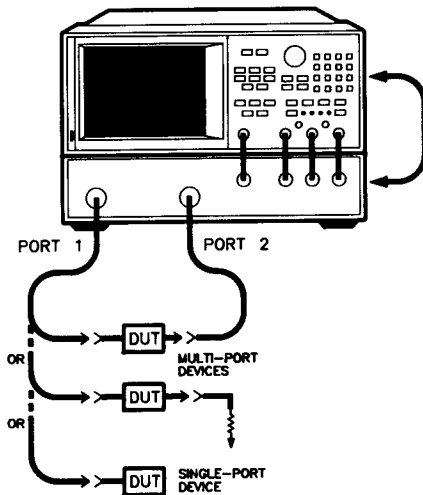

The amount of power reflected from a device is directly related to the impedances of both the device and the measuring system. In fact, each value of the reflection coefficient (Γ) uniquely defines a device impedance; $\Gamma = 0$ only occurs when the device and test set impedance are exactly the same. A short circuit has a reflection coefficient of $\Gamma = 1 \angle 180^\circ$. Every other value for Γ also corresponds uniquely to a complex device impedance, according to the equation

$$Z_n = \frac{1 + \Gamma}{1 - \Gamma}$$

where Z_n is the DUT impedance normalized to (that is, divided by) the measuring system's characteristic impedance (50 or 75 ohms). The network analyzer has a default impedance of 50 ohms. To set the impedance to 75 ohms, press **[CAL]****[MORE]**, **[SET Z0]**. The network analyzer uses the formula above to convert the reflection coefficient measurement data to impedance data.

A Smith chart overlay on the polar display axes lets you read the impedance data in the $R + jX$ format, where R is the resistive component and X is the reactive component of the complex impedance of the DUT. This overlay is generated electronically within the network analyzer, and selected from the **[FORMAT]** menu. Use the same test setup and DUT.

1. Choose Measurement Settings

Press [PRESET] and choose these measurement settings:

Measurement	S11 (or A/R) on CH 1
Format	SMITH CHART
Stimulus	STOP 149 MHz
	START 119 MHz

2. Perform Measurement Calibration

A 1 port calibration is appropriate for this measurement. This cal does not remove mismatch effects from the DUT output, but since this device has more than 20 dB insertion loss, output mismatch is attenuated enough to have very little effect on measurement accuracy. Press [CAL] [CALIBRATE MENU] [S11 1-PORT]. Connect and measure an open, short, and a load to port 1 as prompted.

3. Measure the Device Under Test

Connect the DUT as shown and autoscale.

4. Output the Result

Output the result as desired.

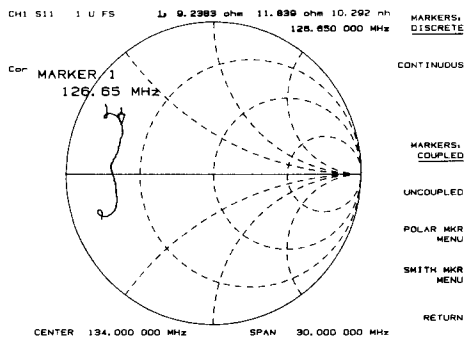

The display shows the complex impedance of the DUT over the frequency range selected. Press [MKR] and use the knob to read the resistive and reactive components of the complex impedance at any point along the trace. Note that the marker annotation tells that the complex impedance is capacitive in the bottom half of the Smith chart display and is inductive in the top half of the display.

Admittance Measurements

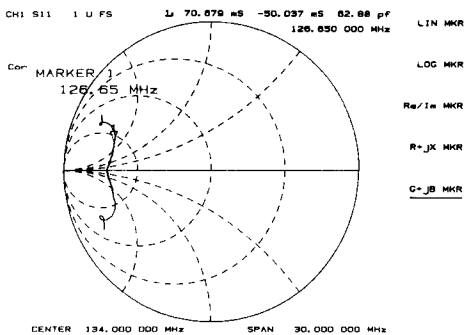

Use the marker to read admittance parameters. From the [MKR] menu, select [MARKER MODE MENU] and [SMITH MKR MENU]. Note that the default selection (currently underlined) is [R + jX MKR] for impedance marker readout. Select [G + B MKR] for an inverse Smith chart overlay. The marker reads the admittance data in the form $G \pm jB$, where G is conductance and B is susceptance, both measured in units of Siemens (equivalent to mhos).

Instrument Feature Tutorials

This chapter explains how to use some of the features and options of a network analyzer system through the following tutorials:

- Disk Drive
- Harmonic Measurements (option 002)
- Limit Lines
- Measurement Calibration
- Printing and Plotting
- Six GHz Operation (option 006)
- Test Sequencing
- Test Sets and S-Parameters
- Time Domain (option 010)

Disk Drive Tutorial

The analyzer lets you save the following information to disk:

- All instrument settings.
- All measurement calibration information.
- Memory trace data stored using the *[DATA →MEMORY]* softkey.
- Limit lines information.
- User-defined frequency list.

Prepare the Disk Drive and Diskette for Use

Select the HP-IB Address. The HP-IB address of the disk drive and the address recognized by the analyzer must match as explained in chapter 1, "Installation."

Select Disk (Drive) Unit 0 or 1. The analyzer should be set to disk unit 0 (the default setting) for use with single disk drives. However, if this setting has been changed, neither PRESET nor cycling line power will reset it. To check the current setting, press:

[LOCAL] [DISK UNIT NUMBER].

To change the setting, press **[0]** or **[1] [x1]**.

Initialize a New Floppy Disk. You must initialize a *new* floppy disk before use (note: initialization *destroys* all current data.) Press:

**[LOCAL] [SYSTEM CONTROLLER]
[SAVE] [STORE TO DISK] [DEFINE STORE] [MORE]
[INITIALIZE DISK] [YES].**

The disk drive busy light will come on for about a minute and a half. When it goes out, the disk is ready for use. Disks need only be initialized once.

Select a Hard Disk Volume Number. If you are using a hard disk, press **[LOCAL] [VOLUME NUMBER] n [x1]** (where n is the desired volume number).

Store Instrument Data to Disk

To store data to disk, press **[SAVE] [STORE TO DISK] [STORE FILE1]** where "FILE1" is the default title (or name) of the disk file.

Select a Filename. To create a file title, such as "DUT1", note these rules:

- A title must begin with a letter, and
- Contain only letters and numbers, and
- Use eight characters or less.

1. Press: **[SAVE] [STORE TO DISK] [TITLE FILES] [TITLE FILE1] [ERASE TITLE]**. A series of letters and numbers will appear on the CRT.
2. Turn the front panel knob until the character selection arrow is under the "D", press **[SELECT LETTER]**.
3. Repeat step 2 for the rest of the characters in "DUT1". Press the **[BACK SPACE]** key to back over an incorrect entry.
4. When finished, press **[DONE] [RETURN] [STORE DUT1]** to store the current instrument data to filename "DUT1".

Disk Storage Troubleshooting

If you encounter a problem, look in the message area on the CRT. Most of the time a message will identify the problem.

- Make sure the disk drive is plugged in, turned on, and has an HP-IB cable connected between it and the instrument.
- Make sure the analyzer recognizes the HP-IB address that the disk drive is set to as explained in chapter 1, "Installation."
- Make sure the disk (drive) unit selected (0 or 1) matches the unit recognized by the analyzer, as explained above.
- Make sure the disk has been initialized by the analyzer, not a computer.
- Make sure the analyzer is in system controller mode (press [LOCAL] [SYSTEM CONTROLLER]).
- In case of continuing difficulties, refer to the *Service Manual*.

Harmonic Measurements (option 002) Tutorial

In addition to measuring gain, an amplifier's harmonic response is often measured. Traditionally, harmonic measurements have been made with a signal generator, and spectrum analyzer at a number of CW frequencies. The HP 8753C with option 002, can make swept second and third order harmonic measurements directly. This capability can significantly reduce component test times. To demonstrate this, a measurement of a preamplifier follows (HP 10855A).

Measuring Swept Harmonics

A harmonic measurement gives the ratio of harmonic signal level to fundamental signal level versus frequency. When set up as shown below, the results can be read directly in decibels, (dBc).

Connect an S-parameter test set to the network analyzer.

1. Choose Measurement Settings

Press [PRESET] and choose these measurement settings:

Measurement	S21 (or B/R) on CH 1
Format	LOG MAG
Stimulus	START 50 MHz
	STOP 1 GHz
	POWER 0 dBm*
	ATTENUATOR PORT 1 20 dB

- * When measuring harmonics, pay close attention to the incident power on your DUT and the analyzer's receiver. By correctly choosing input attenuation and fixed output attenuator values, the DUT's harmonics will be more easily distinguished from those of the analyzer.

2. Perform Measurement Calibration

Substitute a thru for the amplifier under test and perform a frequency response calibration. For gain measurement, this procedure will remove the frequency response and insertion loss errors of the test set. For the swept harmonic measurements, there are some residual errors due to the difference in frequency between the fundamental and the harmonic. They cannot be compensated for.

3. Measure the Device Under Test

Reconnect the amplifier and make the next three measurements as directed.

4. Output the Result

Output any of the results desired as before.

Gain Measurement

This figure shows gain (S_{21}) of the preamplifier.

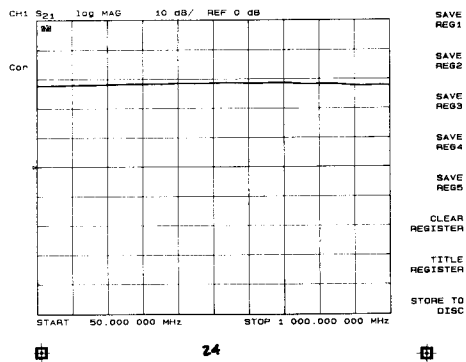

In measuring gain, we are concerned with the ratio of output power to the input power of the amplifier.

For harmonic measurements, measure the harmonic output of the amplifier with respect to its fundamental output. We first need to measure the signal at the output of the amplifier alone. To do this, press [MEAS], [INPUT PORTS], and [B]. This key sequence will allow you to look at only the fundamental signal at the amplifiers output.

Swept Second Harmonic Measurement

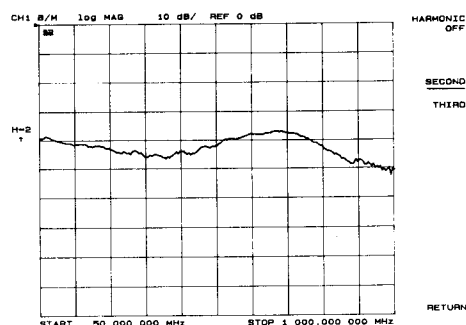

Pressing [DISPLAY], [DATA → MEMORY], and [DATA/MEM] stores the fundamental data in memory and lets us look at incoming data relative to it.

In this example, changing the reference position to the top of the screen [SCALE REF], [REFERENCE POSITION] [1] [0] [x1] will let us view the fundamental and harmonic responses on the same display.

Second harmonic mode [SYSTEM], [HARMONIC MEAS], [SECOND] displays the preamplifier's second harmonic response relative to that of the fundamental (dBc).

Swept Third Harmonic Measurement

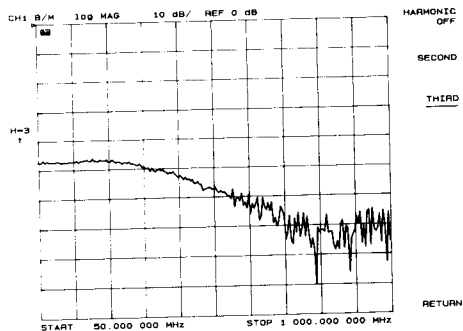

Third harmonic mode [*THIRD*] displays the preamplifier's third harmonic response relative to the fundamental (dBc).

We have quickly measured three important amplifier parameters: gain, second, and third order harmonic responses.

Other measurement techniques, such as the use of marker functions (chapter 3), reflection measurements (chapter 4), and limit lines (later in this chapter) can be adapted easily to enhance and expand the amplifier measurements discussed in this tutorial.

Limit Lines Tutorial

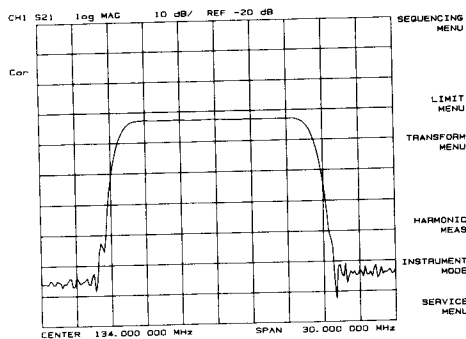

Determine pass or fail status by comparing the device performance to limit lines on the display. In the example, a flat limit line lets you quickly make GO/NO GO testing decisions regarding the filter's pass band ripple by comparing the measurement trace to the limit lines on the display.

To duplicate this example, use the reflection measurement setup of chapter 4 and recall the instrument state saved on page (25). Then modify the measurement settings as follows:

Measurement S21 on CH 1
 Format LOG MAG
 Scale/Ref 10 dB/Reference value -20 dB

To enter the limit line mode, press [**SYSTEM**] and select [**LIMIT MENU**]. To add a new limit segment select [**EDIT LIMIT LINE**], followed by [**ADD**].

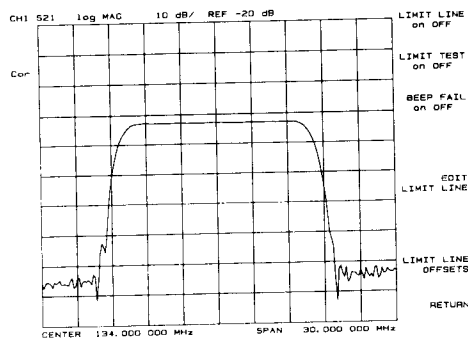

In this example, we enter a [**STIMULUS VALUE**] of 127 MHz (at the start of the filter passband), an [**UPPER LIMIT**] of -21 dB and a [**LOWER LIMIT**] of -23 dB. The SAW filter under test has about 22 dB insertion loss in the passband. Terminate this segment by selecting [**DONE**]. Since this is a flat limit segment select [**LIMIT TYPE**] and [**FLAT LINE**] (the default type). Select [**PRIOR MENU**] to return to the limit line edit menu.

Segment 1 specified the start frequency of the flat limit line. Select [**ADD**] to enter a second limit segment that terminates this flat line. Enter a [**STIMULUS VALUE**] of 141 MHz (the end of the filter passband). The upper and lower limits are copied from Segment 1. Select [**DONE**] to terminate this segment. Since this terminates the limit line select [**LIMIT TYPE**], then [**SINGLE POINT**], and [**PRIOR MENU**] to return to the limit line edit menu.

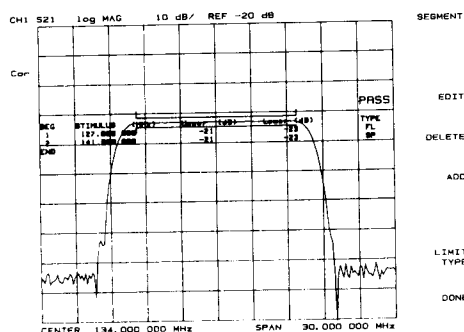

You are now ready to do limit testing. Select [**DONE**] to return to the limit menu. The analyzer draws the limit lines on the display when you select [**LIMIT LINE ON**]. Select [**LIMIT TEST ON**] to activate the limit test. The analyzer tells you whether the DUT passes or fails the limit test with a message along the right hand edge of the graticule. Select [**LIMIT TEST OFF**] and [**LIMIT LINE OFF**] when you are finished with this measurement.

Measurement Calibration Tutorial

Accuracy in network analysis is greatly influenced by factors external to the network analyzer. Parts of the measurement setup such as interconnecting cables and test sets (as well as the instrument itself) all introduce variations in magnitude and phase that can mask the actual performance of the DUT.

Measurement calibration seeks to remove systematic errors (repeatable measurement variations) in the test setup. There are three types of "systematic errors:"

- Frequency Response
- Leakages
- Mismatches

The HP 8753C has several methods of measuring and compensating for these errors. Each method removes one or more of the systematic errors mentioned above using a specific error model (equation). Measurements of standard devices are used to solve for the error terms of the model. The accuracy of the measurement calibration is dependent on the quality of the standards used for calibrating. Since calibration standards are very precise, great measurement accuracy is achieved.

Three measurement calibrations are discussed, starting with the simplest (frequency response) and ending with the most complete (full 2-port).

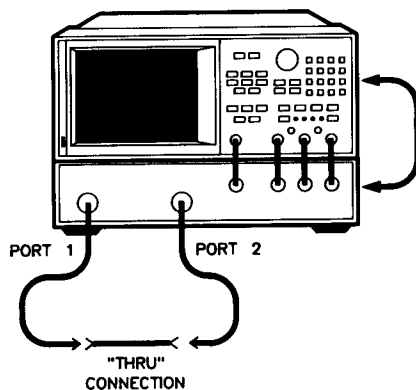

Frequency Response Calibration

- More accurate than no calibration.
- Establishes magnitude and phase reference for transmission or reflection measurements.
- Requires only one connection, one standard, one measurement.
- Simple.

A frequency response calibration removes the frequency response and insertion loss errors of the test setup. This step is also called normalization. For transmission measurements substitute a "thru" connection for the DUT to establish a 0 dB loss (or gain) and a 0° phase reference. For reflection measurements substitute either an open or a short circuit for the DUT to establish a total reflection (0 dB return loss at either 0° or 180° degree phase shift) reference. After the standard is measured, the analyzer underlines the appropriate softkey (either short, open or thru). Press **[DONE: RESPONSE]** to continue.

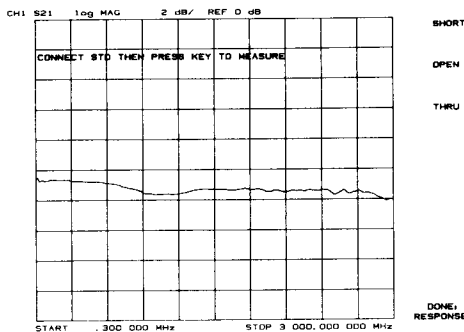

One Port Reflection Calibration

- More accurate than the frequency response calibration.
- Establishes magnitude and phase reference for reflection measurements.
- Requires three connections, three standards, three measurements.
- Good choice for reflection measurements of larger reflection or high insertion loss DUTs.

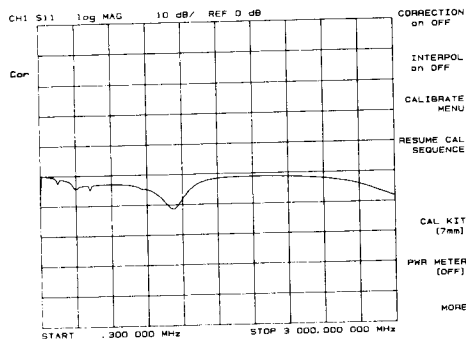
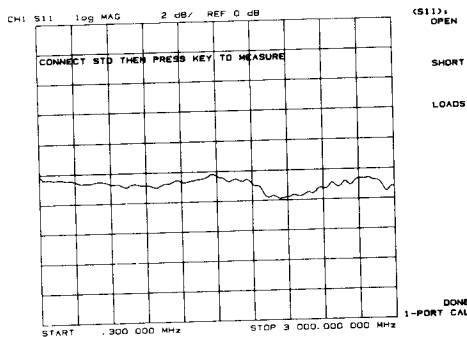

This calibration routine removes all three of the systematic error terms seen from a single input port for a reflection measurement. It does not remove the mismatch effects seen from the DUT output. These output mismatch effects are negligible if either the reflected signal is large or the DUT greatly attenuates the mismatch signals seen from the output port. For example, one port reflection calibration is a good choice when measuring amplifiers or SAW filters because they typically have large reflections or high insertion loss, respectively. *[S11 1-PORT]* and *[S22 1-PORT]* calibrate for reflection measurements in the forward and reverse directions, respectively.

This reflection calibration is simple to perform. Upon pressing either the *[S11 1-PORT]* or *[S22 1-PORT]* softkey, the user is asked to connect a standard open, short and load (50 or 75 ohms). Each is measured in turn, and the results are stored in memory. Upon completion, the analyzer determines the contribution of each of the three error terms and removes its effect from the measured data. Note that correction is turned on when the calibration procedure is complete.

Two Port Calibration

- Most accurate calibration procedure.
- Establishes magnitude and phase reference for both transmission and reflection measurements.
- Requires seven connections, four standards, 12 measurements for Full 2-Port.
- S-parameter test set required for Full 2-Port.

This is the most complete calibration. It measures the three systematic errors (frequency response, leakage and mismatch) in both the forward and reverse directions and removes their effects from the measured data. It is the most accurate calibration for both transmission and reflection measurements.

With an S-parameter test set the measurement results can be corrected for the systematic errors as seen from both measurement ports. Simply press the **[FULL 2-PORT]** softkey and follow the prompts to correct for transmission, reflection and isolation errors. Choose **[OMIT ISOLATION]** except when measuring devices with high dynamic range (for example, some filters and switches). The analyzer has >90 dB isolation between the measurement ports without accuracy enhancement. For high dynamic range measurements, connect loads to measurement ports 1 and 2, choose an averaging factor of 10 or greater, and select **[FWD ISOL'N]** and **[REV ISOL'N]** for isolation accuracy enhancement of >100 dB.

After calibration, the analyzer will turn correction on and switch the source output power between ports 1 and 2 of the S-parameter test set for fully calibrated measurements of all four S-parameters.

Two-port calibrations can be made without an S-parameter test set. For example, to make a full 2-port calibration with the HP 85044A/B transmission/reflection test set, select **[ONE PATH 2-PORT]** and follow the user prompts to measure the reflection, transmission and isolation calibration standards. Two-port calibration requires measuring both the forward and reverse response of the DUT. Since the transmission/reflection test set has only one port (called the test port) the analyzer prompts the user to reverse the DUT after each frequency sweep to measure both the input and output response of the DUT.

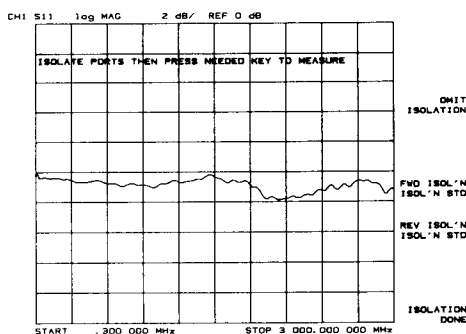
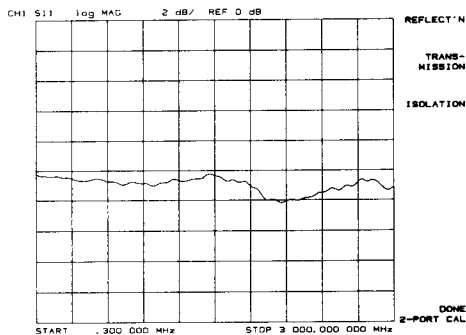
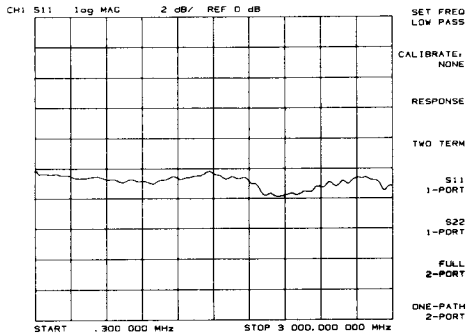

Printing and Plotting Tutorial

Before printing or plotting, always set the analyzer to system controller mode. Press **[LOCAL]** *[SYSTEM CONTROLLER]*.

Printing

Printing Advantages

- Printers are faster than plotters.
- Printers cost less than plotters.

Aligning the Paper

The analyzer does not recognize printer paper perforations. For the best alignment, set the paper so that the printer begins printing at the top of the page.

Identifying the Printer

The analyzer defaults at power up to print to a standard black and white printer. Verify this by pressing **[COPY]**. *[PRINT [STANDARD]]* is the first softkey in the copy menu. "STANDARD" indicates a black and white printer. If "COLOR" is shown in brackets, the analyzer is set to print to a color printer.

To change the printer identification, press **[COPY]** *[PRINT / PLOT SETUP'S]*. For a black and white printer, press *[PRINT: STANDARD]*. For a color printer, press *[COLOR]*.

Printing the Current Display

Press **[COPY]** *[PRINT (STANDARD)]* (or *[PRINT (COLOR)]* for a color printer.) The analyzer will freeze the current display on the CRT and send it to the printer through a buffer. Once the data is transferred to the buffer, the analyzer is available for use while the data is printing.

Printing a List of Measurement Values

The following steps allow you to print a tabular listing of all the measured data points, their current values, and limit information if it is turned on. This information is provided in pages; the number of pages is determined by the number of measurement points.

1. Press **[COPY]** *[LIST VALUES]* *[STANDARD PRINT]* to print the first page.
2. Press **[PAGE]** *[STANDARD PRINT]* to print successive pages.

Adding a Title

Create a title for your display using the title menu under the **[DISPLAY]** key. (See the "Reference" section of the *Operating Manual*.) The title will be printed or plotted with the data.

Plotting

Plotting Advantages

- Plotters have higher resolution than printers.
- Plotters allow portions of the display to be selectively plotted.
- Plots are accurately positioned on the paper.
- Up to four plots can be positioned on one piece of paper using the select quadrant feature (see the *HP 8753C Reference*.)

Aligning the Paper

Load paper in the plotter and set the pen scaling points according to the instructions in the plotter manual.

Plotting the Current Display

Press **[COPY][PLOT]**. The analyzer will freeze the current display on the CRT and send it to the plotter through a buffer. Once the data is transferred to the buffer, the analyzer is available for use while the data is plotting.

Plotting a List of Measurement Values

The following steps allow you to plot a tabular listing of all the measured data points, their current values, and limit information if it is turned on. This information is provided in pages; the number of pages is determined by the number of measurement points.

1. Press **[COPY][LIST VALUES][PLOT]** to plot the first page.
2. Press **[PAGE][PLOT]** to plot successive pages.

Plotting Portions of the Display

The analyzer divides the measurement display into the following categories:

- Data — the displayed trace, or traces.
- Memory — a measurement trace stored in memory that appears on the display.
- Graticule — the display graticule.
- Text — all text shown on the display.
- Markers — the four display markers and their values.

Each category can be turned on or off independently, allowing you to plot only portions of the display. The default configuration is for all of the categories to plot.

Turning Off a Category. Press **[COPY][DEFINE PLOT]** and select from the first five softkeys. For example, **[PLOT GRAT OFF]** causes the graticule to be omitted from subsequent plots.

Changing Pens

Different pens can be selected for each display category (listed previously), limited only by the number of pens in the plotter. This allows you to use pens of various colors or thickness.

To change pen numbers, press **[COPY][CONFIGURE PLOT]**. Select from the first five softkeys and enter a pen number with **[x1]** as the terminator. For example, **[PEN NUM GRATICULE][2][x1]** causes the graticule to be drawn with pen 2 in subsequent plots.

Adding a Title

Create a title for your display using the title menu under the **[DISPLAY]** key. (See the "Reference" section.) The title will be printed or plotted with the data.

Printing and Plotting Troubleshooting

1. Look for an error message on the CRT. (All error messages are explained in chapter 12 of the "Reference" section.)
2. Make sure the device is plugged in, turned on, connected to the analyzer, and loaded with paper.
3. Make sure the analyzer is in system controller mode. Press **[LOCAL][SYSTEM CONTROLLER]**.
4. Make sure the HP-IB address of the device and the address recognized by the analyzer match (see chapter 1, "Installation," in this guide).
5. Replace the HP-IB cable.
6. Substitute a different printer/plotter.
7. If the problem persists, refer to the *Service Manual*.

Six GHz Operation (option 006) Tutorial

Equipment required for 6 GHz operation

- HP 8753C with option 006.
- HP 85047A 6 GHz S-parameter test set.

6 GHz Receiver (option 006)

This option extends the upper frequency limit of the analyzer's receiver to 6 GHz. Option 006 also controls the frequency doubler in the HP 85047A S-Parameter test set.

HP 85047A 6 GHz S-Parameter test set

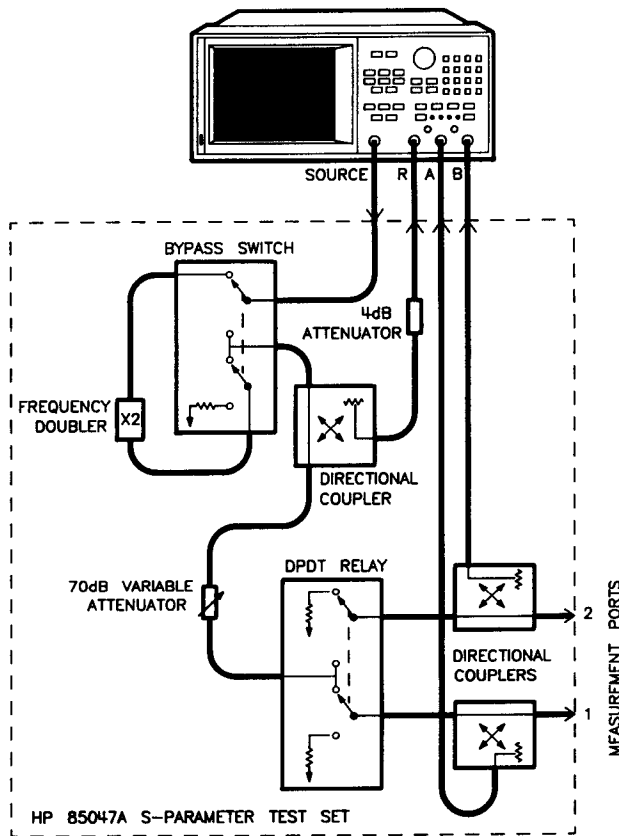

To activate frequency doubler mode press [SYSTEM], [FREQ RANGE 6GHz] or [PRESET], [FREQ RANGE 6GHz], on the front panel of your option 006 equipped HP 8753C. Once activated, the frequency doubler in the HP 85047A S-parameter test set (shown in the adjacent figure), changes the frequency range of the signal output to the DUT from (300 kHz - 3 GHz) to (3 MHz - 6 GHz). The analyzer may be set to operate below 3 MHz in frequency doubler mode and any measurements will be valid in the absence of phase lock error messages.

When the frequency doubler is off, the maximum output power at the test ports is nominally 18 dBm. In frequency doubler mode the maximum output power at the test ports is nominally 3 dBm.

The HP 85047A S-parameter test set has less insertion loss and offers greater maximum power to the test ports than either the HP 85046A, or HP 85044A test sets. Those test sets are detailed in the "Test Sets and S-Parameters" tutorial.

Test Sequencing Tutorial

In component testing it is usually necessary to repeatedly make measurements requiring a series of keystrokes. The test sequencing function allows the user to create, title, save, and execute up to six independent sequences internally. Test sequencing can dramatically reduce the time required to make a multiple step measurement, and will all but eliminate operator error during testing.

Creating a test sequence is virtually identical to making a manual measurement using the front panel. Once you have entered the sequencing mode all you need to do is make the desired measurement. The analyzer will record the keystrokes it took to do so, storing them internally where they can be called up and repeated with a single keystroke. To demonstrate this capability a test sequencing example follows.

Creating a Test Sequence

The following sequence will perform the transmission measurement previously discussed in chapter 3, pause for 2 seconds, perform the reflection measurement previously discussed in chapter 4, again pause for 2 seconds and then simultaneously display both measurements.

This simple example is chosen to illustrate the capability, and ease of use of the test sequencing function. The techniques presented can easily be applied to longer and more complicated test procedures.

[SYSTEM]
[SEQUENCING MENU]
[NEW SEQ/MODIFY SEQ]
[SEQUENCE 1]

Entering test sequencing mode.
Creating a new sequence.
Choosing to store sequence in register 1.

[RECALL]
[RECALL PRST STATE]

Recalling a known instrument state.

[START][119][M/u]
[STOP][149][M/u]
[MEAS]
[Trans: FWD S21 (B/R)]

Setting measurement controls.

[FORMAT]
[LOG MAG]

Displaying log magnitude.

[SCALE REF]
[AUTO SCALE]

Scaling the display.

[SYSTEM]
[SEQUENCING MENU]
[SPECIAL FUNCTIONS]
[WAIT X][2][x1]

Pausing for 2 seconds.

[CH 2]

Displaying channel 2.

[MEAS]
[Ref: FWD S11 (A/R)]

Setting measurement controls.

[FORMAT]
[SMITH CHART]

Displaying Smith chart.

[SYSTEM]
[SEQUENCING MENU]
[SPECIAL FUNCTIONS]
[WAIT X] [2] [x1]

Pausing for 2 seconds.

[DISPLAY]
[DUAL CHAN ON]

Display both channels simultaneously.

[SYSTEM]
[SEQUENCING MENU]
[DONE MODIFY]

Completes the creation process.

Recalling a Test Sequence

To recall and execute the sequence stored in register 1, connect the analyzer, test set, and DUT as shown. Then perform the following operations:

1. Choose Measurement Settings

Press [PRESET] and [SEQUENCE SEQ 1]. Note that the analyzer performs the two measurements previously entered in the test sequence.

2. Perform Measurement Calibration

During execution of a test sequence, the analyzer lets you perform or recall (from external disk or internal register) any calibration. To maintain simplicity, no measurement calibration is used in this example.

3. Measure the Device Under Test

The DUT is automatically measured as part of the test sequence.

4. Output the Result

The adjacent result will be displayed on the CRT when the test sequence has been completed. It could have been output automatically as part of the test sequence by entering the appropriate keystrokes. In this example, the result may now be output manually as desired.

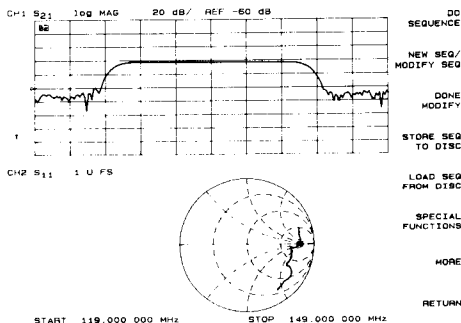

In this very simple example a measurement requiring 30 keystrokes was replaced with just one. A more complicated measurement would further increase instrument productivity, and reduce possibility for operator error.

In addition, the test sequencing function provides if/then decision capability and operator prompts, and can incorporate all of the HP 8753C's standard and optional features (for example, marker functions, limit testing, harmonic analysis).

In an automated testing environment, where many test sequences may be required, external storage/recall of sequences can be used to further enhance the HP 8753C's productivity in a testing environment.

The HP 8753C allows you to cascade multiple sequences to perform longer or more complicated testing procedures.

This feature also allows you to send HP-IB output strings to control external devices, such as signal generators, power supplies or relay actuators.

Test Sets and S-Parameters Tutorial

With one output and three input ports, the HP 8753C can be connected to the DUT in a variety of ways. Simple Insertion loss or gain measurements (B/R) can be made with only a power splitter. Reflection measurements require a coupler or a bridge. Most applications will use a transmission/reflection or S-parameter test set for simultaneous measurements of the transmitted and reflected signals.

HP 85044A/B Transmission/Reflection Test Set

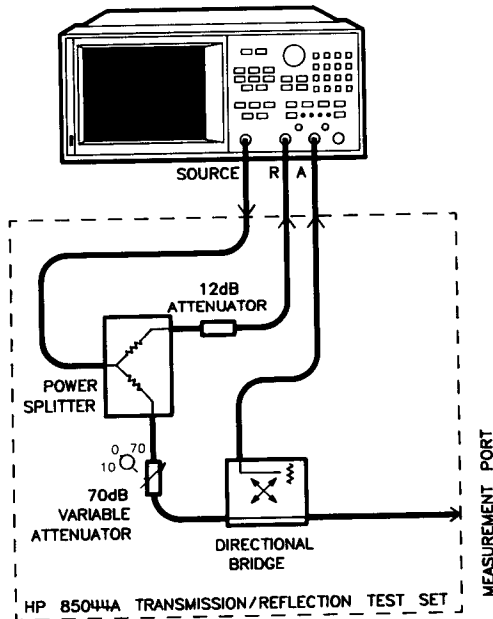

While simple transmission and reflection measurement set-ups can be constructed from discrete RF components such as power dividers, directional bridges, cables, attenuators, etc., it is easier to use an integrated test set such as the HP 85044A/B transmission/reflection test set.

As shown in the diagram, the HP 85044A/B test set contains the hardware required to make simultaneous transmission and reflection measurements in the forward direction. The only setup required is to connect the DUT input to the test port and the DUT output to the B input of the analyzer. The HP 85044A is a 50 ohm test set and the HP 85044B is a 75 ohm test set.

HP 85046A/B S-Parameter Test Set

The S-parameter test set contains the hardware required to make simultaneous transmission and reflection measurements in both the forward and reverse directions. The only setup required is to connect the DUT to the two measurement ports. The network analyzer controls the switching functions, so that even reverse measurements can be made without changing device connections. The internal switch simplifies full 2-port measurement calibrations. The HP 85046A is a 50 ohm test set and the HP 85046B is a 75 ohm test set.

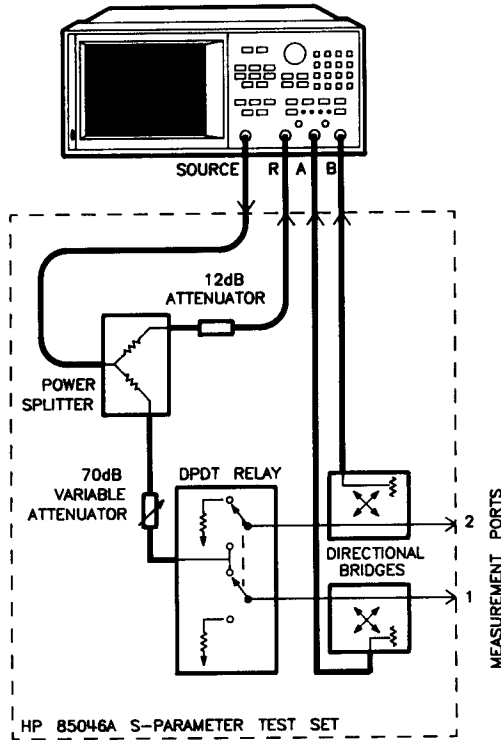

HP 85047A S-Parameter Test Set

This test set is very similar to the HP 85046A but includes a frequency doubler to permit operation to 6 GHz. See the "Six GHz Operation Tutorial" for details.

S-Parameters

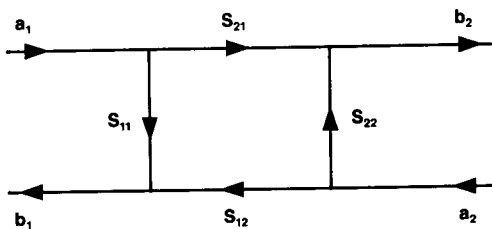

With the S-parameter test set connected the analyzer's [MEAS] menu will read in S-(scattering) parameters. Each choice selects one of the four possible combinations analyzer input modes (A/R or B/R) and test direction (FWD or REV). For those unfamiliar with S-parameters, they correspond exactly to the more common description terms given in the diagram below, requiring only that the measurements be taken with all DUT ports properly terminated. For more information on S-parameters, see HP Application Notes 95-1 and 154, or the "Reference" section of the *Operating Manual*.

S-Parameter	Definition	Description	Test Set Direction	Analyzer Input
S_{11}	$\frac{b_1}{a_1} \Big _{a_2=0}$	Input reflection coefficient	FWD	A/R
S_{21}	$\frac{b_2}{a_1} \Big _{a_2=0}$	Forward gain	FWD	B/R
S_{12}	$\frac{b_1}{a_2} \Big _{a_1=0}$	Reverse gain	REV	A/R
S_{22}	$\frac{b_2}{a_2} \Big _{a_1=0}$	Output reflection coefficient	REV	B/R

Time Domain Analysis (option 010) Tutorial

Transmission Response

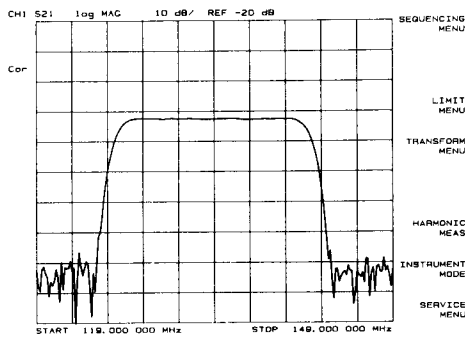

↓ F^{-1}

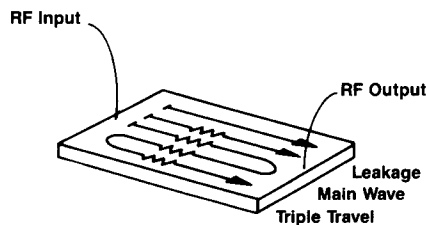
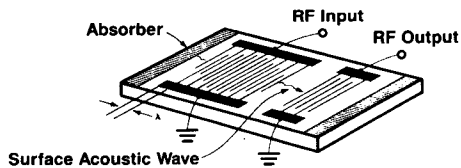
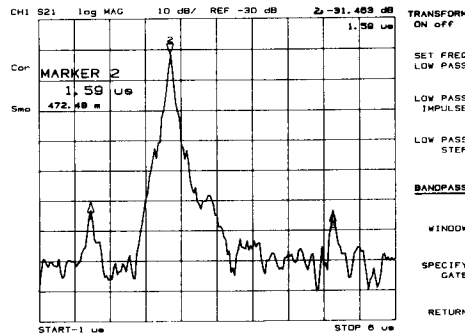

The HP 8753C with optional time domain analysis (option 010) can display the time domain response of the DUT. Time domain analysis is useful for isolating a problem in the DUT in time or in distance. Time and distance are related by the velocity factor of the DUT. The analyzer measures the frequency response of the DUT and uses an inverse Fourier transform to convert the data to the time domain. As examples, use time domain analysis to locate points of reflection (e.g. at connectors and bends) along a transmission line or to separate the individual transmission paths (e.g. main path, leakage and triple travel) through a surface acoustic wave (SAW) filter. This section introduces the time domain concept with a SAW filter example. It concludes with a step-by-step procedure for measuring the time domain response of a cable.

In the example in chapter 3, the transmission response of a SAW filter is measured. The inverse Fourier transform of that transmission measurement is also shown. Note the three components of the transmission response: RF leakage at near zero time, the main travel path through the device (1.6 μ s travel time) and the "triple travel" path (4.8 μ s travel time). Each of these signal paths illustrated in the diagram to the left.

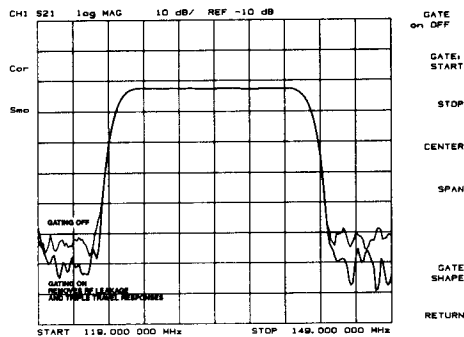
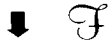
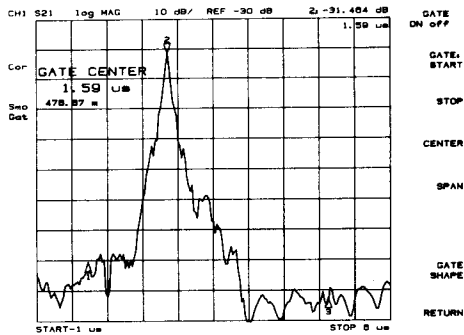

Time domain analysis also lets you mathematically remove individual parts of the time domain response to see the effect of potential design changes. We do this by "gating" out the undesirable responses. In the example shown to the left we see the effect of removing the RF leakage and the triple travel signal path using gating. By transforming back to the frequency domain we see that this design change would yield better out-of-band rejection for the SAW filter under test.

To transform the data from the frequency domain to the time domain, press the [SYSTEM] hardkey and the [TRANSFORM MENU] softkey. Select [BANDPASS] mode to transform the trace on the CRT from the frequency domain to the time domain. The other time domain modes, low pass step and low pass impulse, are described in the HP 8753C *Operating Manual*, "Reference" section.

Reflection Response

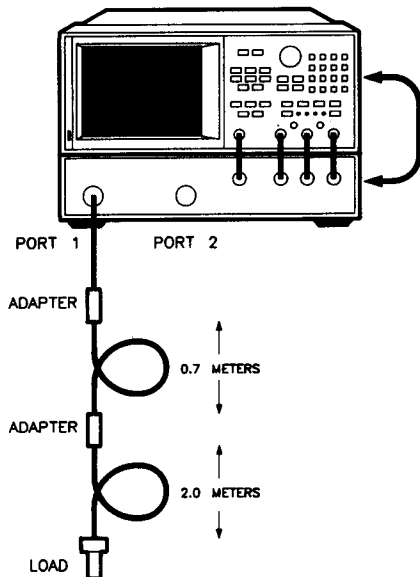

The HP 8753C with optional time domain analysis (option 010) can display the time domain response of the reflection measurement data. The time domain response of a reflection measurement is often compared with the familiar time domain reflectometry (TDR) measurements. Like the TDR measurement, it measures the size of the reflections versus time (or distance). Unlike the TDR, the time domain capability of the analyzer allows you to choose the frequency range over which you would like to make the measurement. With its "gating" capability, the analyzer time domain lets you perform "what if" analysis by mathematically removing selected reflections and seeing the effect back in the frequency domain.

Connect an S-parameter test set to the network analyzer as shown in the figure.

1. Choose Measurement Settings

Press **[PRESET]** and choose these measurement settings:
 Measurement S11 or A/R on CH 1
 Format LIN MAG
 Stimulus START 300 kHz
 STOP 3 GHZ

2. Perform Measurement Calibration

Press **[CAL]** **[CALIBRATE MENU]** **[S11 1-PORT]** and follow the prompts to perform an S11 1-port measurement calibration.

3. Measure the Device Under Test

Connect a test cable, with one or two adapters to make things interesting, as shown in the figure. Terminate the end of the cable. Autoscale the trace.

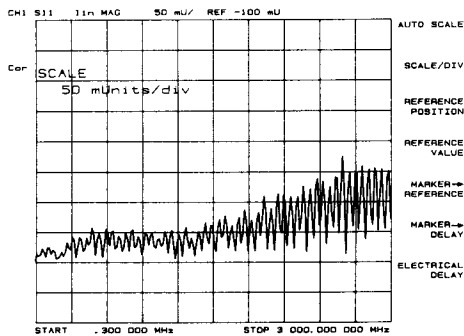

The figure shows the frequency domain reflection response of the cables under test. The complex ripple pattern is caused by reflections from the adapters interacting with each other. By transforming this data to the time domain, you can determine the magnitude of the reflections versus distance along the cable.

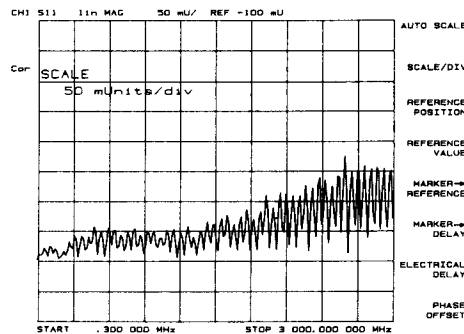

To transform to the time domain press **[SYSTEM]** and **[TRANSFORM MENU]**. Select **[BANDPASS]** transform mode. The low pass impulse mode is most similar to the TDR but we use the bandpass mode in this example because it is simpler. Refer to the "Reference" section of the *Operating Manual* for a complete description of all the time domain operating modes.

Turn the time domain transform on by selecting **[TRANSFORM ON]**. To view the time domain over the length of the cable under test enter a start time of 0 seconds (press **[START]** **[0]** **[x1]**) and a stop time that corresponds to the length of the cable under test. A good rule of thumb is that the energy travels about 1 foot per nano second, or 0.3 meter/ns, in free space. Since most cables have a relative velocity, about 2/3 of the speed in free space, and since you measure the round trip distance to the end of the cable, figure about 3 ns/foot, or 10 ns/meter, for the stop time. In this example, enter a stop time of 40 ns (press **[STOP]** **[4]** **[0]** **[G/n]**) for a cable under test that is about four meters long.

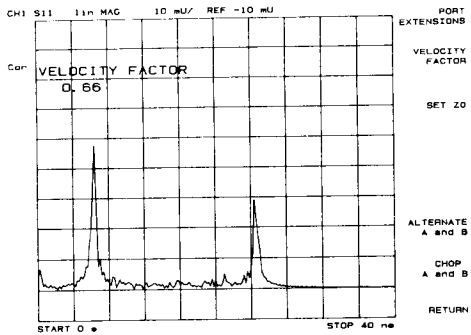

Enter the relative velocity of the cable under test. The markers then read the actual round trip distance to the reflection of interest rather than the "electrical length" that assumes a relative velocity of 1. Press [CAL] and select [MORE] then [VELOCITY FACTOR]. Enter a velocity factor for your cable under test. Most cables have a relative velocity of 0.66 (for polyethylene dielectrics) or 0.7 (for teflon dielectrics). If you would like the markers to read actual one-way distance rather than round trip distance, enter one-half the actual velocity factor.

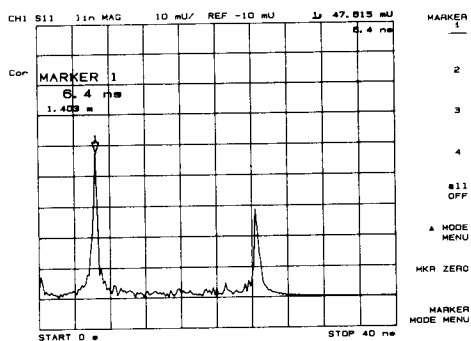

Press [MKR] and use the knob to position the marker on the reflection of interest. Note that the marker reads the time and distance to the reflection in the upper left hand side of the graticule. Loosen one of the connectors to see the corresponding reflection increase.

4. Output the Result

Output the result as desired or just observe the CRT.

How to get the most out of your HP 8753C

This guide concentrates on achieving maximum performance with the HP 8753 network analyzer. These are the major topics:

- Increasing measurement accuracy
- Decreasing sweep time (increasing sweep speed)
- Increasing dynamic range.

Increasing Measurement Accuracy

Factors which affect measurement accuracy include the following:

Calibration Type

Six measurement calibrations are available which remove from one to twelve systematic errors. The full 2-port calibration effectively removes all twelve correctable systematic errors. Some measurements do not require correction for all twelve errors. Chapter 5 of the "Reference" explains each calibration and its uses. Use the proper calibration for each measurement.

Calibrations are valid only for a specific stimulus state which must be set before calibration is begun. The stimulus state consists of the selected frequency range, number of points, sweep time, output power, and sweep type. Changing any of these parameters invalidates the calibration and turns it off unless the interpolated error correction feature is used.

Interpolated Error Correction

Interpolated error correction can be used when a subset of the calibrated frequency range or a different number of points is chosen. The systematic errors are calculated from the errors of the original calibration. The quality of the interpolated error correction depends on the amount of phase shift and amplitude change between measurement points. If phase shift is no greater than approximately 180° per 5 measurement points, interpolated error correction can be a great improvement over uncorrected measurements (the recommended analyzer/test set/cable setups introduce less phase shift). For more information, see chapter 5 of the "Reference".

Calibration Standards

The quality of the error correction provided by a measurement calibration is limited by the difference between the model of the calibration standards and the actual electrical characteristics of those standards. Connector care of the calibration standards is critical to prevent degeneration of the standards.

To use calibration standards other than the default sets, refer to the modify cal kit menu (described in chapter 5 of the "Reference"). Enter the mathematical model for the new calibration standards as directed. The model used by the analyzer will then be the same as the new standards.

Adapters Adapters should be included in the test setup prior to measurement calibration when possible. Adapters added after measurement calibration add reflections and electrical length in the measurement path. These reflections are *not* compensated by a calibration performed before the addition of the adapter. Also, the adapters' electrical length shifts the reference plane. This shift, however, can be compensated for (see "Reference Plane").

Reference Plane To compensate for the phase shift of an extended measurement reference plane due to such additions as cables, adapters, and fixtures, use the port extensions feature. This feature adds electrical delay for all S-parameter measurements intelligently (twice as much added for reflection measurements).

Sweep Time Short sweep times at some narrow IF bandwidths can give rise to measurement inaccuracy as explained in "IF Bandwidth", below.

IF Bandwidth At some narrow IF bandwidths and short sweep times, time delay in the DUT signal path can introduce measurement inaccuracy. This problem can be avoided by forcing the analyzer to sweep in stepped CW mode. Each of these conditions ensures stepped CW mode:

LIST FREQ sweep type
10 Hz or 30 Hz IF BW (bandwidth)
15 msec/point (at 201 points, for example, 3.015 second [0.015x201] sweep time).

To determine whether stepped CW mode is required for your test setup, gradually increase the sweep time and see whether the measurement difference is significant.

Power Meter Calibration Use power meter calibration to monitor and correct RF source power to achieve leveled power at the test port. Power is sampled at each measurement point and a correction data table is generated which the instrument uses to correct the power output of the internal source. Two types of power meter calibration are available: continuous and single sample. Use continuous correction for the greatest accuracy.

Note that this mode is more useful for absolute measurements and has little effect on ratio measurements. See chapter 5 of the "Reference" for further information.

Connector Repeatability Connector repeatability is a major source of random measurement error. Calibrations do *not* compensate for these errors. Refer to the *Microwave Connector Care* manual for instructions regarding inspection, cleaning, gauging, and torquing of connectors.



The connectors provide a direct path to electrostatic discharge (ESD) sensitive devices in the instrument. Always wear a grounding strap and use a static-safe workstation when handling the connectors.

Interconnecting Cables Cables connecting the analyzer and test set and those connecting the device under test to the test set can contribute random error to your measurement. Inspect for lossy cables and damaged cable connectors. Use proper connector care techniques.

Temperature Drift Variations in the ambient temperature will affect the error-corrected measurement uncertainty because of the thermal expansion characteristics of devices within the analyzer system. Graphs of reflection magnitude and phase uncertainty with temperature drift are located in the "General Information and Specifications" section. A temperature-controlled environment limits the measurement uncertainty.

Frequency Drift Minute changes in frequency accuracy and stability can occur as a result of temperature and aging (on the order of parts per million, see the "General Information and Specifications" section). If you require even greater frequency accuracy, override the internal crystal with an external source or frequency standard.

Verification Perform measurement verification to check the accuracy of a calibration. Use accurately known verification standards with diverse magnitude and phase responses. This procedure does not improve measurement accuracy; it is a measure of the accuracy of the existing calibration.

Decreasing Sweep Time The following suggestions for decreasing sweep time are general rules at best. Experimentation is the key to success. To measure sweep time press [MENU] [TRIGGER MENU] [NUMBER of GROUPS] and enter a number followed by [x1]. The analyzer will sweep that number of times and then halt. When experimenting, use auto sweep time mode.

Auto Sweep Time Mode

Auto sweep time mode is the default instrument mode. This mode maintains the fastest sweep speed possible with the current measurement settings. If you have exited this mode and wish to return to it, press [MENU] [SWEEP TIME] [0] [x1]. In this mode the analyzer always sweeps as fast as possible. (In normal mode the analyzer does not automatically decrease sweep time when conditions warrant.)

IF Bandwidth

Press [AVG] to access. Sweep time changes with IF BW as follows:

IF BW	Relative Sweep Time
3000 Hz	1.0
1000 Hz	1.2
300 Hz	2.3
100 Hz	5.3
30 Hz	17.0
10 Hz	50.0

Averaging

Needless to say, reducing the amount of averaging decreases measurement time. But just having averaging on imposes additional computational overhead and increases sweep time. Turning off averaging and using smoothing or a smaller IF bandwidth may produce comparable results in less time.

Number of Points

Press [MENU] to access. Sweep time does not change proportionally with number of points but as indicated below. See also "Sweep Type".

Number of Points	Relative Sweep Time*		
	LIN	LIST	LOG
51	0.8	1.1	1.4
101	0.9	1.6	1.9
201	1.0	2.4	2.8
401	1.3	3.8	4.4
801	1.6	6.4	7.5
1601	2.6	8.4	14.0

Single Channel Display

Press [CH 1] [CH 2] to alternately observe different measurement parameters on 2 channels (instead of using dual channel mode). If you must observe 2 measurements simultaneously (with dual channel), use chop mode (below).

Chop A and B Sweep Mode

Press [CAL] [MORE] to access. Allows simultaneous measurements of S-parameters S_{11} and S_{21} or S_{12} and S_{22} or any combination of input ports. Default mode is alternate sweep; twice as slow.

*Analyzer in preset state, only number of points and sweep type changed.

Measurement Calibration Sweep time increases with measurement calibration complexity (and measurement accuracy). Refer to the "Measurement Calibration" tutorial to evaluate the type of calibration required.

Sweep Type Press [MENU]/[SWEEP TYPE MENU] to access. The relative sweep times of the three types of non-power sweeps are indicated above. But each type of sweep has its advantages and disadvantages.

LIN FREQ. Linear frequency sweep is fastest for a given number of points, but the numbers are fixed. The numbers are 3, 11, and 26 in addition to the numbers listed above.

LIST FREQ. List frequency sweep can be fastest when specific frequency points are of interest (and those points are not listed above or linearly or logarithmically related).

LOG FREQ. Logarithmic frequency sweep can be fastest when the frequency points of interest are those in the lower part of the frequency span selected.

Frequency Span To decrease sweep time, eliminate as many band switches as possible while maintaining measurement integrity. The hardware of the network analyzer sweeps the frequency range in a number of bands. Switching from band to band takes time.

To see the band switch points (steps), press [SYSTEM] [SERVICE MENU] [ANALOG BUS ON] [FORMAT] [MORE] [REAL] [MEAS] [S-PARAMETERS] [ANALOG IN] [15] [x1]. Then enter the intended DUT frequency span. Autoscale and modify the frequency span as appropriate. Bandswitch points are also listed in the manual.

Printing and Plotting Avoid printing or plotting during measurements if the main goal is to minimize sweep time. The analyzer has a buffer and can dump data to the printer or plotter through it. But the analyzer continues to control the device and that control takes time. At such times the analyzer sweep may be visibly slower or motionless.

Other Factors In general, instrument features require computational time for implementation and updating. The time penalty may be small but it is cumulative. Use these features with discretion.

Limit line
Marker search

Limit test
Marker stats

Increasing Dynamic Range

Maximum dynamic range is the difference between the analyzer's maximum allowable input level and its broad-band noise floor. For a measurement to be valid, input signals must be within these boundaries. Thus actual dynamic range is affected by several factors.

Source Output Power

Increase the source output power so that the DUT output power is within the measurement range of the analyzer. (Press **[MENU]**/**[POWER]** and use the entry keys to set the power). There are limits to the maximum power allowed; if a "SOURCE POWER TRIPPED" or "P?" appears, power is too high. Reduce power and reset the power trip under the **[POWER]** softkey.

DUT Output Level

Amplifiers such as the HP 8347A can be used to boost the DUT output within the measurement range of the analyzer.

Noise

IF Bandwidth. Each tenfold reduction in IF (receiver) bandwidth (like 3 kHz to 300 Hz) lowers the noise floor by about 10 dB. (Press **[AVG]**/**[IF BW]** and use the entry keys to set the bandwidth). With the 10 Hz bandwidth a noise floor of -100 dBm is specified. However, narrower bandwidths necessitate longer sweep times. Sweep time is automatically increased as the IF bandwidth is narrowed.

Averaging. The analyzer can apply exponential averaging of successive traces to remove the effects of random noise. (Press **[AVG]**/**[AVERAGING FACTOR]** and use the entry keys to set the averaging level). This type of averaging is explained in the "Reference" section. The full effect of averaging is realized when the CRT indicates the desired number of sweeps have been taken. Thus averaging increases measurement time by requiring more sweeps.

I N D E X

A		
Accuracy, in measurements	49	
Active channel	9	
Adapters	50	
Addresses	8	
Admittance measurements	27	
Aperture	19	
[<i>AUTO SCALE</i>]	13	
Averaging	54	
[<i>AVG</i>]	54	
B		
[<i>BAND PASS</i>]	46	
Bandwidth, 3 dB	14	
Bandwidth, IF	50,52,54	
C		
[<i>CAL</i>]	11	
Calibration	33	
1-port reflection	34	
2-port measurement	35	
Frequency response	33	
Isolation	35	
Calibration kit	49	
[<i>CENTER</i>]	23	
Chop sweep mode	52	
Compression measurements	20	
Connector Repeatability	51	
[<i>COPY</i>]	36	
D		
Data entry	10	
Default conditions	10	
Delay, electrical	18	
Delay, group	19	
Deviation from linear phase	18	
Disk	16,29	
[<i>DISPLAY</i>]	16	
Drift, of instrument due to temperature or frequency	51	
Dual channel display	16	
Dynamic range, optimizing	54	
E		
[<i>ELECTRICAL DELAY</i>]	18	
Electrical length	17	
Electrostatic discharge	4	
Error correction, interpolated	49	
F		
Flatness measurements	15	
[<i>FORMAT</i>]	24	
Frequency list	53	
Frequency response calibration	33	
Frequency span	53	
[<i>FULL 2-PORT</i>] calibration	23	
Fuse information	7	
G		
Gain compression	20	
Gain measurements	12,31	
Gating	46	
Gating time domain responses	46	
General measurement sequence	10	
Group delay	19	
H		
Harmonic measurements	30	
HP-IB settings	8	
I		
IF bandwidth	50,52	
Impedance, measuring	26	
[<i>INITIALIZE DISK</i>]	16,29	
Insertion loss	12,13	
Instrument state keys	10	
Isolation	35	
K		
Keys, differences	11	
L		
Limit lines	32	
[<i>LIMIT MENU</i>]	32	
Limit testing	32	
List frequency	53	
[<i>LOCAL</i>]	8,16	
[<i>LOW PASS</i>]	46	
M		
Marker search	14	
Marker statistics	15	
Markers	13	
[<i>MEAS</i>]	23	
Measurement accuracy	49	
Measurement calibration	33	
Measurement example	11	
Measurement sequence	10	
[<i>MENU</i>]	20	
[<i>Min</i>]	14	
[<i>MKR</i>]	13	
[<i>MKR FCTN</i>]	14	
N		
Noise reduction	54	
Number of points	52	
O		
One-port calibration	34	
Output power	20	
P		
Phase distortion	18	
Phase response	15	
[<i>PLOT</i>]	36,37	
[<i>POLAR</i>]	25	
Polar markers	26	
Power, line	7	
Power meter calibration	50	
[<i>PRESET</i>]	10	
[<i>PRINT</i>]	36	
Q		
Quality factor	14	
R		
Rack mounting	6	
[<i>Recall</i>]	25	
Reference plane	50	
Reflection coefficient	22	
Reflection measurements	21	
Response keys	9	
Return loss	22	
Ripple measurements	15	
S		
[<i>S11 1-PORT</i>] calibration	34	
[<i>S22 1-PORT</i>] calibration	34	
[<i>SAVE</i>]	25,29	
[<i>SCALE REF</i>]	13	
Second harmonic	31	
[<i>SET ADDRESSES</i>]	8	
Signal separation	42	
Site requirements	5	
Six GHz operation	39	
Smith chart	27	
Smith markers	27	
Smoothing	19	
[<i>SPAN</i>]	23	
S-parameters	42,44	
S-parameter test sets	43	
Split display	16	
[<i>START</i>]	11	
Statistics	15	
Stimulus keys	9	
[<i>STOP</i>]	11	
Storing data to disk	29	
[<i>SYSTEM CONTROLLER</i>]	11	
Sweep time	50,51	
Sweep type	53	
SWR	22	
T		
Termination, device	21	
Third harmonic	32	
Test sequencing	40	
Test sets	42	
Time domain measurements	46	
Time domain modes	45	
[<i>TRANSFORM MENU</i>]	46	
Transmission measurements	12	
Transmission/reflection test set	42	
V		
Velocity factor	48	
W		
Widths	14	

For more information, call your local HP sales office listed in your telephone directory or an HP regional office listed below for the location of your nearest sales office.

United States:

Hewlett-Packard Company
4 Choke Cherry Road
Rockville, MD 20850
(301) 670-4300

Hewlett-Packard Company
5201 Tollview Drive
Rolling Meadows, IL 60008
(312) 255-9800

Hewlett-Packard Company
5161 Lankershim Blvd.
No. Hollywood, CA 91601
(818) 505-5600

Hewlett-Packard Company
2015 South Park Place
Atlanta, GA 30339
(404) 955-1500

Canada:

Hewlett-Packard Ltd.
6877 Goreway Drive
Mississauga, Ontario L4V1M8
(416) 678-9430

Australia/New Zealand:

Hewlett-Packard Australia Ltd.
31-41 Joseph Street,
Blackburn, Victoria 3130
Melbourne, Australia
(03) 895-2895

Europe/Africa/Middle East:

Hewlett-Packard S.A.
Central Mailing Department,
P.O. Box 529
1180 AM Amstelveen,
The Netherlands
(31) 20/547 9999

Far East:

Hewlett-Packard Asia Ltd.
22/F Bond Centre
West Tower
89 Queensway
Central, Hong Kong
(5) 8487777

Japan:

Yokogawa-Hewlett-Packard Ltd.
29-21, Takaido-Higashi 3-chome
Suginami-ku, Tokyo 168
(03) 331-6111

Latin America:

Latin American Region Headquarters
Monte Pelvoux Nbr. 111
Lomas de Chapultepec
11000 Mexico, D.F. Mexico
(905) 596-79-33



April 1, 1989

Copyright ©1989
Hewlett-Packard Company
Printed in U.S.A.
08753-90157